

Islamic Republic of Iran
Vice Presidency for Strategic Planning and Supervision

Guideline for Seismic Design of Water supply systems

No. 604

Office of Deputy for Strategic Supervision

Department of Technical Affairs

nezamfanni.ir



omoorepeyman.ir

Table of content	Page number
Chapter 1-General	
1-General	3
1-1-Objective	3
1-2-Scope.....	3
1-2-1-Organization of this guideline	3
1-2-2-Application notes.....	4
1-3-Related codes and regulations.....	4
1-3-1-Normative references.....	4
1-3-2-Code Abbreviations	5
Chapter 2- Principles	
2-Principles.....	9
2-1-Design earthquake.....	9
2-1-1-Risk levels of earthquake and their return period.....	9
2-1-2-Seismic design spectra.....	10
2-1-3-Distribution of seismic intensity in stories	11
2-1-4-Vertical seismic intensity of design.....	11
2-2-1-Design methods	11
2-3-Anticipated functions in this guideline	12
Chapter 3- Seismic Loading	
3-1-Load types.....	15
3-2-Weight calculation	15
3-3-Loads mixture	15
3-4-Types of equipments in terms of location.....	15
3-5-Methods for calculating seismic loads	15
3-6-Effects of earthquake on water supply equipments	16
3-7-The manner in which the effects of earthquake are applied to water equipments	16
3-8-Methods of calculating seismic loads	16
3-8-1-Water supply system components importance factors.....	18
3-8-2 -Response displacement method (for buried structures).....	19
3-8-3-Dynamic method	19
3-9-Loading due to geotechnical hazards of earthquake on equipments.....	20
3-9-1-Liquefaction.....	20
3-9-2-Landslide	20
3-9-3-Faulting.....	20
3-10-Soil Classification	21
3-11-Earth pressure during earthquake.....	21
3-11-1-Overview	21
3-11-2-Calculation of horizontal earth pressure during earthquake	21
3-11-2-1-Soil classification for calculating earth pressure.....	21
3-11-2-2-Active pressure during earthquake	21
3-11-2-3-Passive earth pressure.....	23
3-11-3-Calculation of vertical earth pressure during earthquake	24

3-11-4-External pressure caused by lateral spreading	24
3-11-5-Liquefaction-induced floatation	25
3-12-Hydrodynamic pressure during earthquake and water turbulence.....	25
3-12-1-Hydrodynamic pressure during earthquake	25
3-12-1-1-Overview	25
3-12-1-2-Distribution of dynamic pressure of water in tanks	26
3-12-2-Water turbulence	28
Chapter 4- Seismic Design and Safety Control Methods	
4-2-Seismic design process	33
4-2-1-Seismic design principles	33
4-2-2-Design using the allowable stress method.....	33
4-2-2-1-Calculation of design stress.....	34
4-2-2-3-Evaluation of the calculated stress	34
4-2-3-Plastic design method phases	34
4-2-3-1-Risk level for the plastic design method	34
4-2-3-2-Seismic response analysis	35
4-2-3-3-Ductility factor	38
4-2-3-4-Allowable ductility factor	39
4-2-3-5-Ductility factor evaluation	39
4-3-Special tips for seismic design of each of the components of urban water supply systems	39
4-3-1-Intake	39
4-3-2-Collector channel.....	39
4-3-3-Well	39
4-3-4-Open channel and tunnel	40
4-3-5-Buried pond and tank	40
4-3-6-On-ground and aerial water tanks.....	41
4-3-7-Piping	42
4-3-8-Water supply pipelines	43
4-3-8-1-Seismic performance of different pipelines	44
4-3-8-2-Seismic design of pipelines must be carried out according to the following process:	45
4-3-8-3-Buried pipelines design phases	47
4-3-8-4-On-ground pipeline seismic design.....	47
Chapter 5- Seismic Design and Safety Control of Treatment Ponds and Buried Tanks	
5-Treatment Ponds (and Buried Tanks)	51
5-1-Seismic calculation method	51
5-1-1-Overview	51
5-1-2-Quasi-static method.....	51
5-1-3-Response displacement method.....	51
5-1-4-Dynamic analysis	51
5-1-5-Calculation modeling	52
5-2-Effects of earthquake	52
5-3-Seismic input	53
5-3-1-Seismic coefficient	53
5-3-2-Ground horizontal displacement by response displacement method.....	54



5-3-3-Ground period.....	54
5-3-4-Earth pressure	54
5-3-5-Hydrodynamic pressure.....	54
5-3-6-Turbulence.....	54
5-4-Load combination	55
5-5-Structural considerations.....	55
5-6-Operational details for safer performance during earthquake.....	58
Chapter 6 -Seismic Design and Safety Control of On-Ground and Aerial Water Tanks	
6-1-On-ground tanks	65
6-1-1-Seismic calculations method	65
6-1-2-Quasi-static method	65
6-1-3-Equivalent seismic coefficient method.....	66
6-1-4-Analytic model	67
6-1-5-Effects of earthquake.....	67
6-1-6-Seismic input	67
6-1-6-1-Design seismic coefficient	67
6-1-6-2-Design period of on-ground tanks	67
6-1-6-3-Earth pressure.....	68
6-1-6-4-Hydrodynamic pressure.....	68
6-1-6-5-Turbulence.....	68
6-1-7-Load combinations	68
6-1-8-Seismic calculations of on-ground tanks	69
6-1-9-Structural considerations	75
6-2-Aerial tanks	76
6-2-1-Seismic calculations method	76
6-2-2-Effects of earthquake.....	77
6-2-3-Seismic input	77
6-2-4-Load combinations	81
6-2-5-Seismic calculations of aerial water tanks	82
6-2-6-Structural considerations	83
6-3-Allowable values.....	84
6-4-Response analysis of aerial and on-ground tanks	84
6-4-1-Application of the finite element method	85
6-4-2-External forces conditions	87
6-4-3-Calculation conditions	91
6-4-4-Element partitions.....	91
Chapter 7- Seismic Design and Safety Control of Water Supply Pipelines	
7-1-Water supply pipelines.....	95
7-2-Target components.....	95
7-3-General considerations on seismic design of pipelines.....	97
7-4-Buried pipelines	99
7-4-1-Response displacement method for pipeline design.....	99
7-4-1-1-Seismic design input.....	99
7-4-1-2-Velocity spectrum	99

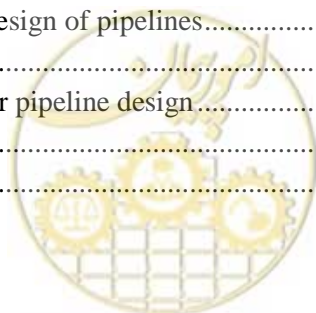

7-4-1-3-Dominant ground period	99
7-4-1-4-Wavelength	99
7-4-1-5-Horizontal ground displacement	99
7-4-1-6-Vertical ground displacement	100
7-4-1-7-Ground strain.....	100
7-4-1-8-Soil stiffness coefficient in the allowable stress method.....	100
7-4-1-9-Ground friction force in the plastic design method.....	101
7-4-2-Calculations of unbroken pipelines using the displacement response method.....	101
7-4-2-1-Overview	101
7-4-2-2-Calculation of pipe body stress in the allowable stress design method.....	101
7-4-2-3-Calculation of the stress of unbroken pipe body (using the plastic design method)	102
7-4-2-4-Calculation of the strain of pipe body (Design of unbroken pipelines using the allowable stress method).....	102
7-4-2-5-Calculation of the strain of pipe body in the plastic design method	103
7-4-3-Calculations of disjoint pipelines using the displacement response analysis method	103
7-4-3-1-Overview	103
7-4-3-2-Calculation of the stress of pipe body (disjoint ductile iron pipeline regardless of slippage).....	103
7-4-3-3-Calculation of the stress of pipe body (disjoint ductile iron pipeline by considering the amount of slippage)	104
7-4-3-4-Calculation of the stress of pipeline (disjoint steel pipeline regardless of slippage)	104
7-4-3-5-Calculation of the strain of disjoint pipe (disjoint pipeline considering the amount of slippage).....	105
7-4-3-6-Calculation of the axial displacement of junctions	105
7-4-3-7-Calculation of the bending angle of junctions.....	106
7-4-4-Calculation and safety control of permanent ground displacement beneath pipelines.....	107
7-4-4-1-Overview.....	107
7-4-4-2-Arrangements against PGD in disjoint pipelines	107
7-4-4-3-Calculations of disjoint pipelines subject to liquefaction effects	107
7-4-4-3-1-Lateral ground displacement next to the retaining wall.....	108
7-4-4-3-2-Lateral displacement of slope ground.....	109
7-4-4-3-3-Evaluation of seismic safety for liquefaction-induced permanent ground displacements.....	110
7-4-4-5-Calculation of pipe strain due to fault displacement.....	112
7-4-4-6-Calculations related to landslide	113
7-4-4-6-1-Overview.....	113
7-4-4-6-2-Buried pipes response to longitudinal PGD.....	114
7-4-4-6-3-Buried pipes response to transverse PGD.....	115
7-4-4-7-Special conditions for pipes	116
7-4-5-Calculations of shafts, conduits, common channels, and bucklers using the seismic coefficient and the displacement response analysis methods.....	118
7-4-6-Calculations of shafts, conduits, common channels, and bucklers using the dynamic analysis method.....	123
7-5-On-ground pipeline.....	124
7-5-1-Overview	124
7-5-2-Seismic coefficient of on-ground structures in the allowable stress design method	124
7-5-3-Horizontal earthquake caused by the superstructure to the substructure.....	125

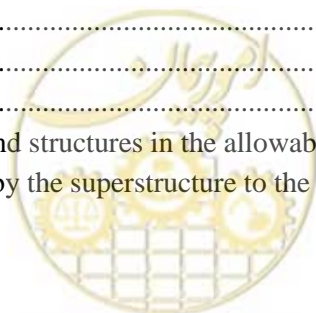

7-5-4-Horizontal inertia force.....	125
7-5-5-Earth pressure	126
7-5-6-Hydrodynamic pressure during earthquake	126
7-5-6-1 hydrodynamic pressure in the pipelines and channels on bridge abutments	126
7-5-6-2-Hydrodynamic pressure in the pipelines placed on abutments	126
7-5-6-3-Hydrodynamic pressure in piers in contact with water and abutments	128
7-5-7-Bearing support structures	128
7-5-7-1-Overview	128
7-5-7-2-Bearing supports design seismic force	128
7-5-7-3-Safety control of the bearing support	129
7-5-7-4-Seat length.....	129
7-5-7-5-Unseating prevention systems	130
7-5-7-5-1-General.....	130
7-5-7-5-2- Structure.....	130
7-5-7-5-3-Design seismic force	131
7-5-7-5-4-Structures constraining excessive displacements.....	132
7-5-8-Allowable quantities of buried pipelines	132
7-6-Criteria	133
7-6-1-On-ground pipeline.....	133
7-6-2-Buried pipelines.....	133
7-6-2-1-Disjoint pipeline in the plastic design method regardless of soil slippage.....	133
7-6-2-2-Disjoint pipeline in the plastic design method regarding soil slippage	133
7-6-2-3-Unbroken pipeline in the allowable stress design method	133
7-6-2-4-Unbroken pipeline in the plastic design method	133



Chapter 1

General



1-General

This guideline has been developed based on similar documents in the high seismicity countries together with local experiences and experiences from other countries outstanding in the field of earthquake engineering. In line with gaining from other countries' experiences; it has been tried to pay attention to the localization issue and present subjects more simple and practical.

1-1-Objective

The objective of this guideline is to secure public safety and prevent serious damage to water supply systems due to earthquake

- Seismic design of water supply systems is presented in this guideline.
- In this guideline water supply system consists from dewatering facility to consumer branch.
- Vulnerability against earthquake is very critical, so the objective of this guideline is to secure acceptable safety regarding to rational risk on the basis of economic conditions and the nature of earthquake hazard and vulnerability of water supply systems.
- The aim of this guideline is to no serious and interfering public safety damage occur by observance of its content.

1-2-Scope

Intended installations of this guideline are installations of water supply system including water supply components, Water purification components, pondage components, pipelines and distribution networks.

- Iran 2800 code and Iran's National Building Regulations are used for seismic design of the structures of this system
- Subjects regarding to National Building Regulations, chapter 4, issue 360 and issue 123 can be used for seismic design for foundation of equipment together with results extracted from seismic design of related instrument from this guideline.

This guideline is used to seismic design of following facilities.

A- Watershed facilities that including watershed tower, watershed pipe, collective channels, wells, channel and free tunnel.

B- Refinery and pumping station that including treatment basin facilities and buried tanks, above ground tanks, aerial tanks, pipeline and supports.

C- Transmission and distribution pipelines that including buried pipeline, lined culvert and tunnel, open channel and above ground lines such as pipeline bridge or Aqueduct Bridge.

1-2-1-Organization of this guideline

This guideline was organized with above mentioned objectives and scope into following chapters:

Chapter 1: general

Chapter 2: principles

Chapter 3: seismic loading

Chapter 4: methods of seismic design and safety control

Chapter 5: Seismic Design and Safety Control of Treatment Ponds and Buried Tanks



Chapter 6: Seismic Design and Safety Control of On-Ground and Aerial Water Tanks

Chapter 7: Seismic Design and Safety Control of Water Supply Pipelines

1-2-2-Application notes

Since this document is the first narrative of the respective guideline in the country, like previous guidelines and regulation, the presence of ambiguity and impediments is a normal issue. For lessen these difficulties and remove them as soon as possible, it is worthwhile to consider following notes:

1-It has been tried to remove any contradictions between regulations of this guideline with Iran 2800 code.

2-In the case of scarcity of information about loading intended water supply system in this guideline, topic six of National Building Regulations can be implemented.

3- For designing concrete components of intended water supply facilities in this guideline, especially concrete material characteristics, issue 123 and topic 9 of National Building Regulations can be implemented.

4-Topic 10 of National Building Regulations is complementary for obviate any shortcomings regarding steel components of its electrical facilities.

5-Other similar guidelines and documents which occasionally were prepared and developed by internal or external qualified bodies for seismic design of water supply systems can be implemented in coordination with this guideline.

6-It is expected from all users of this guideline to send their corrections and recommendations for its better compliance and easier implementation in the country to be used for developer in the future versions.

1-3-Related codes and regulations

1-3-1-Normative references

Various standards, codes, regulations, guidelines and manuals were used in the development of this guideline. The most important of them are as following:

JWWA1997: specifications of seismic design and construction of water supply facilities, Japan water supply association, 1997.

Iran 2800 Code: Iranian Code of Practice for Seismic Resistant Design of Buildings, Standard No. 2800, Building and Housing Research Center, 2005

Euro code 8: Design rules for the earthquake-resistant structures, Part 4: silos, storage tanks and pipeline systems, European Committee for Standardization, 2006

BCJ1997: specifications of seismic design for building components ,Building Center of Japan, 1997

Japan Road Association: Specifications for Highway Bridges, Part V, Seismic Design, 2002

High Pressure Gas Safety Institute of Japan (KHK): Seismic Design Code for High Pressure Gas Facilities, 2006

Building Center of Japan: guideline of seismic design and construction of building equipments,1997.



1-3-2-Code Abbreviations

Abbreviation	Full Name
ALA2005	Seismic Guidelines for water Pipelines, ALA, 2005
ASCE7	Minimum Design Loads for Buildings and Other Structures, ASCE, 2006
AWWA96	AWWAD100-96
BCJ1997	Specifications of seismic design for building components, Building Center of Japan, 1997
BS EN1998-1	Euro code 8: Design of structures for earthquake resistance. Part 1, General rules, seismic actions and rules for buildings, European Committee for Standardization, 2004
BS EN1998-4	Euro code 8: Design rules for the earthquake-resistant structures, Part 4: silos, storage tanks and pipeline systems, European Committee for Standardization, 2006
JIS B8501	Japanese Industrial Standard, JIS B8501, Welded Steel tanks for oil storage, 2001
JGA1982	Recommended methods for earthquake-resistant design for high and medium pressure gas pipelines, Japan Gas Association, 1982
JGA2001	Recommended methods for earthquake-resistant design for high pressure gas pipelines in the areas with potential of liquefaction, , Japan Gas Association, 2001
JSWA2006	Seismic Design and Construction Guidelines for Sewage Installations, Japan Sewage Works Association, 2006
WSP064	Design Standard for Water Pipe Bridge, WSP 064-2007, Metallic Water Pipe Association
UBC97	Uniform Building Code, USA, 1997



Chapter 2

Principles



2-Principles

Principles regarding earthquake design, design methods (safety control) and anticipated performances are presented summarily in this chapter. The most important of these principles are:

- 1- Two risk level following Iran 2800 code with attention to two acceleration and velocity spectrum compatible with Iran's condition and in accordance with regulations of Standard No. 2800
- 2- Consideration of earthquake load in two types including inertia force due to the acceleration effect in mass that exerted in to gravity mass center or centers and the force due to earth displacements and its application through interaction of soil and buried structure to the body in the contact with soil.
- 3- Using two method for design and safety control including allowable stress in the elastic limit of material behavior for risk level 1 and ductility method in non-elastic of material behavior for risk level 2
- 4- Using two level of performance as damage limit and ultimate limit which unceasing utilization and minimum cease are secured in the former and latter, respectively. With regard of the behavior of structural components, that remains undamaged in the elastic limit, in the former, but in the latter, passes from the yield boundary but bounds to the certain allowable limit of plastic deformation. This allowable limit after yield-allowable ductility- is determined by this guideline according to experimentations or experiences.

They are described summarily in the following.

2-1-Design earthquake

2-1-1-Risk levels of earthquake and their return period

1-Two risk level mentioned in the following must be considered for seismic design of components of water supply network system

Risk level 1: Maximum Operational Earthquake (MOE) (occurrence probability 50% during 50 years of assumed useful service)

Risk level 2: Maximum Considerable Earthquake (MCE) (occurrence probability 10% during 50 years of assumed useful service)

2-In Iran, magnitude (magnitude of momentum) and fault distance must be considered on the basis of occurrence probability of MOE and MCE in the facility sites.

1-In this guideline, useful service life of lifelines including desired water supply facilities is considered relatively around 50 years. Maximum operational earthquake may be occurred once or twice during the service of water supply facilities. Unacceptable failure modes during operation of facilities are confined to risk level 1 and operation of water supply system continues reliably. In this risk level, occurrence probability of 50% during 50 years is in accordance with return period of 72 years. In standard no. 2800, overrun probability is considered around 99.5% which gives return period of about 10 years.

Maximum earthquake of design is an earthquake with lower occurrence probability and longer return period than to earthquake of MOE. The behavior of water system components in the risk level 2 is in the ultimate mode and the whole system, even if a member is damaged, must maintain its stability. The occurrence probability of 10% for earthquake with higher magnitude during 50 years is in accordance with return period of 475 years.

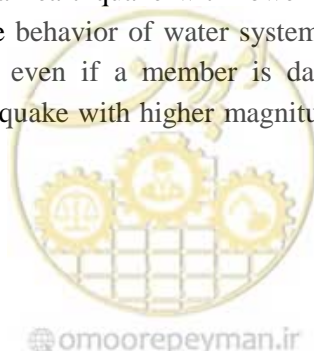

With regard of risk management, overrun probability of 10% has versatile and suitable application in the economic term with consideration of requisite safety. For some structures such as bridges which their life are considered up to about 250 years, this overrun probability in risk gives return period of 2475 years that gives overrun probability of about 2% for structures of useful service life of 50years such as buildings and lifelines that is not economic.

In some fields such as dam construction, the term MCE means Maximum Credible Earthquake. In this guideline, this term is adopted from chapter 12 of ASCE-7-05 and used with the same meaning.

2-For estimation of Permanent Ground Deformation (PGD) due to fault displacement (faulting), liquefaction and landslide, earthquake magnitude M and fault distance R are required. M , R and other related seismic parameters are obtained from analytic or experimental relations resulted from designer desired region risk analysis, especially with regard to its seismicity records.

2-1-2-Seismic design spectra

1-Response spectra of seismic design for water supply facilities must be computed according to natural period and decay characteristics of structural systems. Also, load due to earthquake must be computed by means of these spectra.

2-Spectrum dynamic analyses for seismic safety control of structural systems must be done by mixing modal spectrum characteristics.

3-One of two following response spectra must be used for designing water supply facilities.

A-Acceleration response spectrum for computation of inertia force due to the mass of above ground components.

B-Velocity response spectrum for computation of interactional force due to the displacement of soil on the body of buried components.

1-In the application these spectra, following notes must be considered:

1-1-In this guideline, elastic response spectrum is used for decay of 5%

1-2-response spectrum for seismic design is obtained from following methods:

A- Probabilistic methods have more engineering applications. Spectra from these methods usually have lower values than to their equivalents from deterministic methods.

B- Deterministic spectra are often used for conservative design and crisis management.

When the importance and value of structure and equipment increase, the one of these methods is used for extracting site specific spectra.

Site specific spectra are computed according to seismic activities, active faults and geomorphologic conditions. Regulations of standard no. 2800 are used for obtaining site-specific spectra. Moreover, velocity spectrum must be extracted for buried structures.

2-Analyse of dynamic response is a method for seismic safety control of structure, especially structures with complex behavior under earthquake. These analyses are expensive and time-consuming and only used when there is difficulty and uncertainty in application of response spectra.

3-Following points must be considered regarding to spectrum

3-1-acceleration response spectrum is used for above-ground structures. Also, these spectra are convenient for systems with several degrees of freedom with application of modal analysis method.

In this guideline, for all kind of loading and seismic design requires acceleration, acceleration spectrum available in the valid and current version of standard no. 2800 or site specific spectra is used for computations relied on acceleration spectrum.

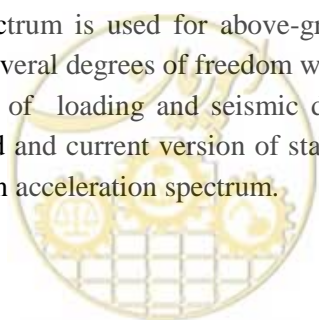

3-2-Velocity response spectra are used for seismic analysis and design of underground structures such as pipelines, shielded tunnels and underground reservoirs which their action are controlled with seismic behaviors of surrounding soils. Earthquake loading of such structures are done on the basis of displacement response in which, soil deformation in the location of buried structures are computed with usage of velocity response spectrum firstly and then interaction between ground and buried structures is determined by static methods.

3-3-Velocity and acceleration response spectra must be compatible with seismic design of water supply facilities. In the first version of this guideline, a velocity response is proposed that is nearly compatible with standard no. 2800. For next versions it is required to develop a series of velocity spectrum (as acceleration spectrum in standard no. 2800).

2-1-3-Distribution of seismic intensity in stories

Seismic design intensity of stories is used for water supply system components located on other facilities or in the upper stories. In stories simplified coefficient distribution (A_i) use for distribution of seismic intensity (K_H), that is given by equation (2-1). This coefficient multiplied at K_H in every stories.

$$A_i = 1 / \sqrt{\frac{H-x}{H}} \quad (2-1)$$

H: Total height of stories

x: the height of stories above the stories of i

Seismic intensity for equipment located on the height over equipment or another structure is a function of seismic intensity on their position. For equipment inside structures, equipment behavior in earthquake will depend on story which is based on it.

2-1-4-Vertical seismic intensity of design

Seismic inputs of vertical direction must be considered for equipment which their behavior is sensitive to the vertical component of earthquake. Vertical seismic intensity of design K_v is given by equation (2-3):

$$K_v = \frac{1}{2} K_H \quad (2-2)$$

Which, K_H is seismic intensity of the design in horizontal direction.

In this guideline for each of components that is presented the chapter 5 and next chapters, their horizontal and vertical earthquakes are computed, appropriately. In almost all of the cases, vertical earthquake is accounted as half of horizontal earthquake.

2-2-1-Design methods

Safety of designed equipment must be controlled via following methods:

- 1-Allowable stress design method which must be applied on the risk level 1
 - 2-Horizontal force capacity method: this method can be applied for risk level 2 with consideration of maximum lateral forces due to structural deformation in the ultimate mode.
 - 3-Ductile design method which compare existing ductile ratio of structure with allowable ductile ratio for risk level 2.
- In the cases which equipment are of very high importance or certain complexity exists in seismic behavior, convenient dynamic methods are used for control of above mentioned methods according to the design

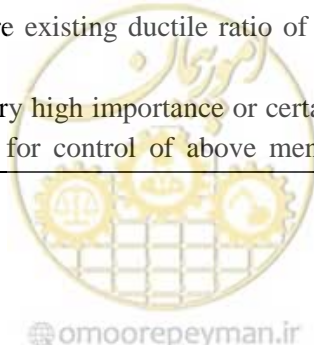

engineer.

1-For limit state of damage, the created stress of structural member is compared with allowable stress in elastic range. Generally, allowable stress design method is used in risk level 1 for operation earthquake.

2-Horizontal (lateral) force capacity method is one of the control methods. This method has been used in the seismic design of some components of water supply systems in this guideline and applied appropriately with related details.

3- Equivalent ductile design method (alternative method) is a method in which component stress is computed using one equivalent elastic design spectrum. This spectrum is obtained from multiplication of factor in one spectrum of elastic seismic design. This factor is determined according to ductility coefficient or structures' capacity for absorb energy. In this guideline, this coefficient is considered to be 0.5.

3-The basis of the ductile design method is to give more allowance to structure to absorb more energy (after yield point of material) for more strong earthquake with high acceleration (and velocity) so their components can absorb more strains. Computed ductility coefficient is controlled with formulae of this guideline with appropriate allowable ductility coefficient. Sometimes, ductility coefficient can be described in terms of structural strains.

2-3-Anticipated functions in this guideline

Two functions are considered in this guideline for water supply system components for given risk levels:

- Unceasing usage function (until before material yield)
 - Risk level 1: designed components must not damage water supply system function effectively and their function must be continued unceasingly.
- Minimum interruption of function (after material yield)
 - Risk level 2: designed components may inflict drastic physical damage function but without any effect on lives, environment and sustainability of water supply system. Inflicted damage must be removable as soon as possible and faulted function must be rehabilitated.

In risk level 1, structural members must not be impaired any physical damage that interrupt system usage. This level is called "limit state or mode". In this mode, each building member of system must be in the elastic extent of stress-strain relations and not be reached to yield limit.

In risk level 2, members of structural systems can be physically damaged parochially but systematic and structural sustainability must not be destroyed. This level is called "ultimate state or mode". In this mode, non-elastic deformations (after material yield) may be occurred.

In general, anticipated classification of function in two limit modes has been considered in other codes and guidelines but in detail, they are different. In this guideline, implementation procedure of these limits according to designed components are presented in chapter 5 and afterward chapters based on allowable design stress method (for limit mode of damage) and ductile methods of design (for ultimate limit mode) and needed computations and criteria are given.



Chapter 3

Seismic Loading



3-1-Load types

Calculating loads for water supply systems equipments are of the following types:

- Dead load resulting from the weight of each item of equipments and its accessories.
- Weight resulting from the contents of some of the equipments.
- Contents internal pressure (especially in vessels, tanks, piping systems and pipelines).
- Hydrostatic and hydrodynamic pressures caused by water (water load).
- Load exerted by soil on the buried components (soil load).
- Load caused by heating.
- Lateral and vertical seismic loads.
- Wind load.
- Traffic load.

For different types of loads, based on the components incorporated in the water system, the following considerations shall be taken into account:

- ✓ Wind load does not have any effects on the buried structures.
- ✓ Unlike buildings, water facilities structures do not have any human live loads.
- ✓ Components such as tanks, pipelines and piping systems connecting the equipments are mainly affected by the pressure caused by the self-weight of the material and components contained in them.
- ✓ Stacks and the piping system connecting the equipments are affected by loads resulting from high temperatures.

3-2-Weight calculation

Use the sixth section of the national building guideline for calculating the unit weight of aggregates and different loads.

3-3-Loads mixture

In this guideline, loading and load combination for any certain equipment are covered in chapter 5 and its consequent chapters.

3-4-Types of equipments in terms of location

Water supply system equipments are generally located as follows:

- Aerial equipments
- On-ground equipments
- Underground and buried equipments

3-5-Methods for calculating seismic loads

Seismic loads are applied to water system equipments in the following forms:

- 1-Inertia force resulting from the masses of the equipments that are not confined to move in the earth. This force is mainly calculated for aerial structures and on-ground structures.
- 2-Load resulting from bed soil displacements, which is exerted on buried structures. In this case, soil

displacement is multiplied by the spring constant of the structure and the soil then the resulting force is applied to the equipments.

3-6-Effects of earthquake on water supply equipments

The effects of earthquake on water supply system equipments can be classified into the following two types and the seismic loading for each type is calculated separately:

1-Dynamic effects of earthquake caused by ground vibrations (distribution of seismic waves in soil), calculation of which results in the following three responses:

- Acceleration (in on-ground and stationary structures results in inertia force)
- Velocity (in buried structures, especially in conveyance and distribution lines, is more effective than acceleration)
- Displacement (seriously damages all types of structures, especially conveyance lines buried in the ground)

2-Static effects or geotechnical hazards, which cause permanent ground displacements that are of the following types:

- Liquefaction (and lateral spreading, especially in the banks of seas and rivers)
- Landslide (in foothills with steep slopes).
- Faulting (in station structures located on faults or buried lines crossing beneath them)

The application manner of the seismic loads resulting from the aforementioned effects is described in the following sections regarding different methods introduced in the Guideline of Loading and Seismic Analysis of Lifelines.

3-7-The manner in which the effects of earthquake are applied to water equipments

- To calculate the load applied to on-ground and aerial components, the inertia force resulting from the effects of earthquake acceleration on the masses of equipments should be calculated. In this method a spectrometer is used based on the standards included in Standard 2800.
- To calculate the inertia force resulting from the effects of acceleration, the “quasi-static method” is employed. When the equipment period is long or the equipment has structural complexity (i.e. when the 1st mode of structure vibration is not true), the “modified quasi-static method” is employed.
- To calculate the effects of the force resulting from ground displacements on buried structures, the “Response Displacement Method” is used. In this method after calculating ground displacement in the specific areas and determining the spring constant of the soil surrounding the structure, the applied force is calculated. In this method a velocity spectrum compatible with the acceleration spectrum in Standard 2800 or a site-specific velocity spectrum is used.
- In the response displacement method, by calculating the strain of the surrounding soil regarding the viscosity between the buried structure and its surrounding soil, the strain of a buried structure can be calculated.

3-8-Methods of calculating seismic loads

In order to determine the seismic force applied to aerial and on-ground components of water systems, the “quasi-static method” is often employed. Moreover, the following methods can also be used based on the

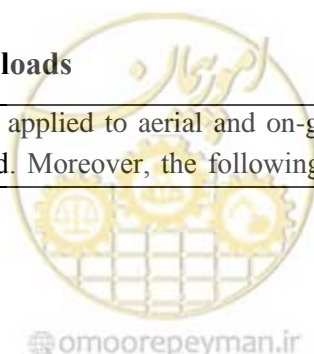

form, seismic properties, importance level of the facilities, and the failure mode of the structures.

- Modified quasi-static method
- Dynamic analysis method (spectral or time history)

The quasi-static method is used to calculate displacement and strain of a structure of high rigidity, by applying seismic load as the equivalent static load. The equivalent static load is obtained by multiplying the earthquake factor by the structure mass.

In the modified quasi-static method, the natural period and damping of the structure, along with the inertia force resulting from the earthquake are calculated and the correction coefficient is used as compared to the quasi-static method. In addition to these methods, in order to control the simple static methods and have a more precise understanding of the seismic behavior of components and to ensure the functionality of the design, the spectrum/time history dynamic analysis methods are used. In such methods, the reliability of the results is dependent on the appropriateness of the input accelerations and the selected damping coefficients.

Description:

Due to the varied behavior and importance of water system components, different common methods are employed for their seismic analysis.

Table (3-1) gives an illustration of this classification. The abbreviations used in this table include:

- (SCM): Seismic Coefficient Method
- (RDM): Response Displacement Method
- (DAM): Dynamic Analysis Method



Table 3-1: Seismic analysis methods of water system components

Structure		Seismic Analysis Method		
		Risk level 1	Risk level 2	
Intake	Water inlet valve		SCM	SCM, if needed DAM
	Water inlet tower		SCM	SCM, if needed DAM
	Water inlet pipe/treatment gallery	Both the longitudinal and transverse directions	RDM	RDM
	Well		RDM	RDM
Water transmission/delivery line	Open channel	Transverse direction	RDM	RDM
		Longitudinal direction	RDM	RDM, if needed DAM
	Transmission tunnels	Transverse direction	RDM	RDM
		Longitudinal direction	RDM	RDM, if needed
Pipelines	Pipe bridge/bridge-crossing pipe		SCM	SCM, if needed DAM
	Buried pipeline	Transverse direction		-
		Longitudinal direction	RDM	RDM, if needed DAM
	Shaft, closed channel, T-tunnel		SCM or RDM	SCM or RDM, if needed DAM
Water tanks	Treatment pond and buried tanks		SCM or RDM	SCM or RDM, if needed DAM
	On-ground and aerial tanks		SCM or DAM	SCM, if needed DAM

3-8-1-Water supply system components importance factors

Importance factor of a structure is shown by (β_1) and is determined according to the following Table (3-2) based on its level.

Table 3-2: Importance factor, β_1

Importance level	Very high	High	Average	Low
β_1	1/4	1/2	1	0/8

The need for continuous utilization of the design component and the necessity of ensuring its safety after earthquake play an important role in increasing the importance factor of that specific component in the water supply system. Descriptions of different levels of importance are provided in Table (3-3), and importance-based classifications of different facilities and lines are provided in Table (3-4).

When two levels of importance are assumed to exist, employer's judgment determines the final importance level.



Table 3-3: Definition of different importance levels of equipments

Importance level	Description
Very high	Components whose malfunction leads to vast amounts of casualties, financial losses and damages to equipments and environment.
High	Components that their malfunction can lead to water cut, casualties or human, financial and environmental losses.
Average	Components that their malfunction disrupts water supply.
Low	Components that their malfunction does not have a significant effect on water supply systems and also does not cause financial and environmental losses and damages.

Table 3-4: Importance classification of facilities and lines

Importance classification	Status of facilities and lines in the system
Very high/high	Facilities that have the potential to cause severe minor events. Facilities located in the upstream of water supply systems. Primary facilities that have no backup facilities. Main feeders to critical facilities. Primary facilities which are hard to repair in case of being damaged. Facilities that will act as data collection centers during natural disasters.
Average/low	Other facilities and lines

3-8-2 -Response displacement method (for buried structures)

This method is developed based on *beam on elastic foundation theory*. In this method by using the earthquake velocity response spectrum and by assuming the first mode of soil shearing vibration the extent of displacement is calculated and based on the elasticity of the soil is transformed into the effective force acting on the structure.

In the following chapters seismic loading for each item of equipments is described regarding the above methods.

3-8-3-Dynamic method

In this method the mathematical model of each item of equipments subject to spectral loading or time history, and is solved through solving the dynamic equilibrium equations. The dynamic method is normally used to control the static or quasi-dynamic methods or to analyze critical or complex structures.

In using the dynamic method to achieve more precision the following considerations shall be taken into account according to Standard 2800:

- Choosing the appropriate input from different acceleration time histories.
- Choosing the appropriate spectrum.
- Close-to-reality modeling.
- Choosing an appropriate number of suitable seismic models.
- As actual as possible damping coefficients.

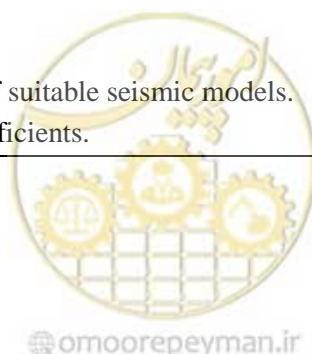

3-9-Loading due to geotechnical hazards of earthquake on equipments

In addition to earth shakes during earthquake, equipments must be also immune to loads resulting from earthquake-induced geotechnical hazards. The most important hazards include liquefaction (and lateral spreading), landslide, and faulting.

3-9-1-Liquefaction

Although the potential for liquefaction is not high in Iran, in the coastal areas of the seas, rivers and in some areas where the level of fine sand geotextiles and underground water are high, this hazard endangers different equipments including the buried ones.

- Seismic design against liquefaction should be carried out by reviewing the seismic performance of a structure under steady-state liquefaction-induced ground displacements and by considering ground conditions.
- Areas that need seismic design against liquefaction should be selected based on their geology, geomorphology, ground conditions, and the location of the sites allocated for installation of water supply facilities.

Steady-state liquefaction-induced ground displacements are of the following types:

- Horizontal displacement caused by lateral spreading in a gradient.
- Horizontal displacement caused by lateral spreading of the ground in coastal areas.
- Settlement

The effect of liquefaction is calculated as vertical and horizontal displacement and is applied according to the distribution on the buried structure.

If water facilities, such as pipelines, are installed on deep piles, settlement can be neglected.

3-9-2-Landslide

In mountainous areas with steep slopes and loose layers, landslides can happen and can cause damage to various water equipments.

In order to confront landslide hazards, which are caused by the steady-state ground displacements, required assessments should be carried out according to the following phases:

- Assessing the ground potential for landslide
- Assessing the ground potential for starting landslide and slope deformation
- Assessing the possibility of landslide and slope deformation occurrence
- Assessing the hazards of landslide and slope deformation

3-9-3-Faulting

Crossing areas with the potential for faulting is inevitable for water supply systems. Hence, the effects of displacement on active faults on those structures that belong to these systems and cross these faults should be taken into consideration to the possible extent.

- The existence of an active fault should be determined using the geological parameters associated with the shape of that active fault.
- The possible location of an active fault should be determined and verified through geological surveys, geophysical explorations, boring explorations, and examination of trenches.
- If water supply facilities cut an active fault, their design should be compatible with their desired seismic performance regarding the steady-state ground displacements induced by fault displacements.

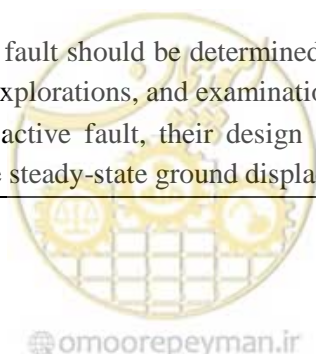

- If the effects of fault displacement become evident on the ground, the seismic design of water supply facilities should be carried out in line with fault displacements.

The calculation and application manner of loads resulting from seismic geotechnical hazards is explained in the third chapter covering lifelines.

3-10-Soil Classification

To simplify the usage of the relations included in Standard 2800, the soil classification introduced in this standard is also employed here.

3-11-Earth pressure during earthquake

3-11-1-Overview

For seismic design of structures tied to the ground, earth pressure during earthquake is calculated in the manner explained below. The effect of vertical component of earthquake is introduced into the relations as $(1 \pm K_{sv})$.

Horizontal earth pressure during earthquake is derived from the earth pressure relation in Mononobe-Okabe theory.

3-11-2-Calculation of horizontal earth pressure during earthquake

In order to calculate horizontal earth pressure during earthquake, the amount of soil viscosity should be considered as well.

3-11-2-1-Soil classification for calculating earth pressure

In order to classify soil and determine different parameters of earth pressure see Table (3-4).

Table 3-5: Soil type and parameters used for calculating earth pressure

Soil type	Unit weight (kN/m^3)		Internal angle of friction (deg)
	Normal conditions	Under water conditions	
Size of particles of a mix of sand, gravel and rock	20	10	40
Natural sand and gravel	20	10	35
Loose sand	18	8	30
Clay (with wall heights less than 10 meters)	18	8	30
Clay soil (with wall heights more than 10 meters and special seismic conditions)	The value tested in the soil test shall be used.		

Viscosity resistance is neglected.

3-11-2-2-Active pressure during earthquake

- 1- Neglecting viscosity
 - 1-1-unsaturated soil



$$P_{aE} = (1 - K_{SV}) \left\{ \gamma h_g K_{AE} + \frac{q \cos \alpha}{\cos(\alpha - \beta)} K_{AE} \right\} \quad (3-1)$$

$$F_{aE} = (1 - K_{SV}) \frac{1}{2} \left\{ \gamma h_g^2 K_{AE} + \frac{q \cos \alpha}{\cos(\alpha - \beta)} h K_{AE} \right\} \quad (3-2)$$

P_{aE} : active pressure during earthquake (kN/m²)

F_{aE} : driving force during earthquake (kN/m)

K_{AE} : coefficient of active pressure during earthquake

$$K_{AE} = \frac{1}{\cos \theta \cos^2(\alpha + \beta + \theta)} \cdot \frac{\cos^2(\phi - \beta - \theta)}{\left\{ 1 + \sqrt{\frac{\sin(\phi + \delta) \sin(\phi - \beta - \theta)}{\cos(\alpha + \alpha + \beta) \cos(\alpha - \beta)}} \right\}^2} \quad (3-3)$$

Note that this relation is not applicable when $\alpha + \beta + \theta \geq 90^\circ$. When $\phi - \beta - \theta$, the result of this relation is considered to be zero in calculations.

$$\theta = \tan^{-1} \frac{K_{SH}}{1 - K_{SV}} \quad (3-4)$$

(K_{SH} : design horizontal earthquake factor , and K_{SV} : design vertical earthquake factor).

The value of θ varies depending on the value of K_{SH} and K_{SV} .

γ : soil unit weight (kN/m²)

h_g : Height from ground surface to the location of determining earth pressure.

q : uniform load for per unit length of slope (kN/m²)

α : angle between the structure surface corresponding to vertical face (deg)

β :angel between the ground surface corresponding to the datum horizon at the back of a structure (deg)

ϕ :inner angle of friction of soil (deg)

δ :angle of friction between structure surface and soil (deg)

1-2-Knowing the amount of underground water level

$$P_{aE'} = (1 - K_{SV}) \left\{ \gamma' h_g K_{AE}' + \frac{q \cos \alpha}{\cos(\alpha - \beta)} K_{AE}' \right\} \quad (3-5)$$

$$F_{aE'} = (1 - K_{SV}) \frac{1}{2} \left\{ \gamma' h_g^2 K_{AE}' + \frac{q \cos \alpha}{\cos(\alpha - \beta)} h K_{AE}' \right\} \quad (3-6)$$

Where:

$P_{aE'}$: active pressure during earthquake when the underground water level is available. (kN/m²)

$F_{aE'}$: active force during earthquake when the underground water level is available. (kN/m)

K_{AE}' : coefficient of active pressure during earthquake when the underground water level is available.

$$K_{AB}' = \frac{1}{\cos \theta' \cos^2(\alpha + \beta + \theta')} \cdot \frac{\cos^2(\phi - \beta - \theta')}{\left\{ 1 + \sqrt{\frac{\sin(\phi + \delta) \sin(\phi - \beta - \theta')}{\cos(\alpha + \delta + \theta') \cos(\alpha - \beta)}} \right\}^2} \quad (3-7)$$

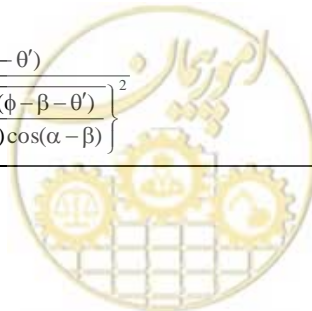

$$\theta' = \tan^{-1} \left(\frac{K_{SH}}{1 - K_{SV}} \cdot \frac{\gamma}{\gamma'} \right) \quad (3-8)$$

Where:

γ' : unit weight (kN/m³)

2- Considering viscosity

By considering the viscosity force and the height of the self-retaining walls in cohesive soil, calculations are performed using the following relations:

$$P_{aE} = \gamma(h_g - z_0)K_{AE} + \frac{q \cos \alpha}{\cos(\alpha - \beta)} K_{AE} \quad (3-9)$$

$$F_{aE} = \frac{1}{2} \gamma(h_g - z_0)^2 K_{AE} + \frac{q \cos \alpha}{\cos(\alpha - \beta)} h K_{AE} \quad (3-10)$$

Where:

z_0 : height of the self-retaining walls in cohesive soil (m)

$$z_0 = \frac{2C}{\gamma} \tan\left(45^\circ + \frac{\phi}{2}\right)$$

Where:

C : soil viscosity (kN/m²)

3-11-2-3-Passive earth pressure

1- Neglecting viscosity

1-1-unsaturated soil

$$P_{PE} = (1 - K_{SV}) \left\{ \gamma h_g K_{PE} + \frac{q \cos \alpha}{\cos(\alpha - \beta)} K_{PE} \right\} \quad (3-11)$$

$$F_{PE} = (1 - K_{SV}) \left\{ \frac{1}{2} \gamma h_g^2 K_{PE} + \frac{q \cos \alpha}{\cos(\alpha - \beta)} h K_{PE} \right\} \quad (3-12)$$

Where:

P_{PE} : passive earth pressure during earthquake (kN/m²)

F_{PE} : passive soil force during earthquake (kN/m)

K_{PE} : coefficient of passive earth pressure during earthquake

$$K_{PE} = \frac{1}{\cos \theta \cos^2(\alpha + \beta + \theta)} \frac{\cos^2(\phi - \beta - \theta)}{\left\{ 1 + \sqrt{\frac{\sin(\phi + \delta) \sin(\phi + \beta - \theta)}{\cos(\alpha - \delta - \theta) \cos(\alpha - \beta)}} \right\}^2} \quad (3-13)$$

1-2-when the underground water level is available

$$P'_{PE} = (1 - K_{SV}) \left\{ \gamma' h_g K'_{PE} + \frac{q \cos \alpha}{\cos(\alpha - \beta)} K'_{PE} \right\} \quad (3-14)$$

$$F'_{PE} = (1 - K_{SV}) \left\{ \frac{1}{2} \gamma' h_g^2 K'_{PE} + \frac{q \cos \alpha}{\cos(\alpha - \beta)} h K'_{PE} \right\} \quad (3-15)$$

Where:

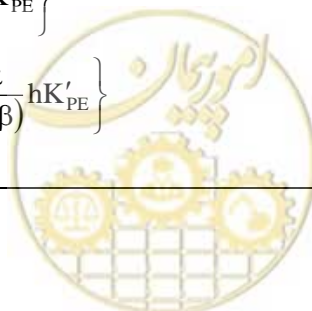

P'_{PE} : passive earth pressure force during earthquake (kN/m²)

F'_{PE} : passive soil force during earthquake (kN/m)

K'_{PE} : coefficient of passive earth pressure during earthquake

$$K'_{PE} = \frac{1}{\cos\theta' \cos^2(\alpha - \beta - \theta')} \frac{\cos^2(\phi + \beta - \theta')}{\left\{ 1 - \sqrt{\frac{\sin(\phi + \delta) \sin(\phi + \beta - \theta')}{\cos(\alpha - \delta - \theta') \cos(\alpha - \beta)}} \right\}^2} \quad (3-16)$$

When $\phi + \beta - \theta' < 0$ the above relation is not applicable.

2- Considering viscosity force

$$P_{PE} = \gamma(h_g + z'_0)K_{PE} + \frac{q \cos\alpha}{\cos(\alpha - \beta)} K_{PE} \quad (3-17)$$

$$F_{PE} = \frac{1}{2} \gamma(h_g + 2z'_0)hK_{PE} + \frac{q \cos\alpha}{\cos(\alpha - \beta)} hK_{PE} \quad (3-18)$$

z'_0 : height of the self-retaining walls in cohesive soil (m)

$$z'_0 = \frac{2C}{\gamma} \tan\left(45^\circ - \frac{\phi}{2}\right) \quad (3-19)$$

3-11-3-Calculation of vertical earth pressure during earthquake

Vertical earth pressure exerted on buried pipelines should be taken into consideration in calculations. Earth pressure applied to buried pipelines during earthquake can be calculated using relation (3-20).

Load pressure exerted on buried pipelines supported by pile foundations during earthquakes is calculated using relation (3-21).

$$W_S = \gamma_s h_g D(1 \pm K_{SV}) \quad (3-20)$$

$$W_S = \frac{e^{2K\mu(h_g/D)} - 1}{2K\mu} \gamma_s D^2 (1 \pm K_{SV}) \quad (3-21)$$

Where:

W_S : vertical earth pressure per unit length of pipe line (kN)

h_g : height earth lining (m)

γ_s : soil unit weight (kN/m³)

D : pipeline outside diameter (m)

K_{SV} : vertical earthquake factor

K : Rankine active earth pressure coefficient

μ : coefficient of friction

3-11-4-External pressure caused by lateral spreading

In a ground that is prone to liquefaction-induced lateral spreading, seismic design of the foundation structure is carried out by considering the external force resulted from such spreads. In this case, the effects of superstructure and substructure inertia forces are neglected.

- 1- The pressure induced by liquefaction flow (which is exerted on a buried structure) in the liquefying earth layer, is less than 30% of the total pressure.

2- Non-liquefying layer of soil above the liquefying layers of earth has the most passive earth pressure due to the application of external pressure by other layers. Lateral current due to external pressure is illustrated in Figure (3-1). Vertical active earth pressure coefficient for the non-liquefying layer is expressed as $K=0.3$.

External force caused by lateral current affects an area of 100 meters on the wall. As it is depicted in Figure (3-2), when the distance from wall is reduced, earth pressure is also declined.

For the purpose of seismic analysis, this relation is used as follows:

$$P'_p = \beta \cdot P_p$$

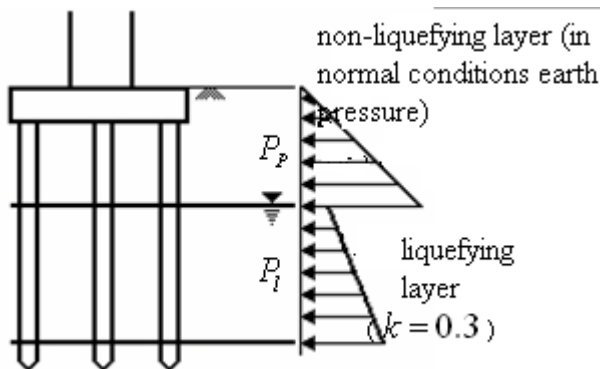

Figure 3-1: External force due to lateral currents

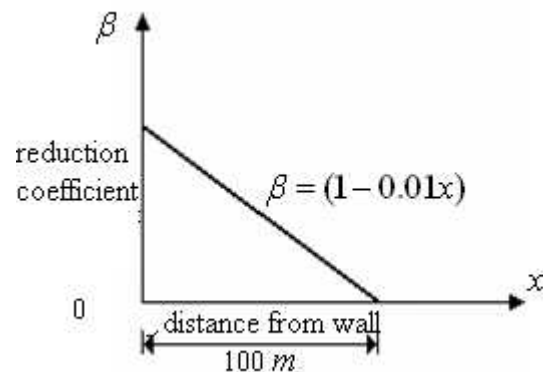

Figure 3-2: the relation between earth pressure and the distance from the wall

3-11-5-Liquefaction-induced floatation

If F_L of the soil surrounding buried structures is less than 0/1, the structure's safety against floatation should be examined. Floatation control for a buried structure is carried out using relation (3-23).

$$F_u = \frac{W_B + Q_1}{V_0 \cdot \gamma_s} \quad (3-23)$$

Where:

F_u : floatation safety

W_B : weight, including the contents weight of the underground structure per unit length (kN/m)

Q_1 : shear strength of the non-liquefying layer of earth. F_t is less than 1/0 regardless of shear strength caused by materials such as road pavement aggregates (kN/m).

V_0 : volume per unit length of the buried structure (m^3/m)

γ_s : weight per unit volume of saturated sediment surrounding the buried structure (kN/m^3)

3-12-Hydrodynamic pressure during earthquake and water turbulence

3-12-1-Hydrodynamic pressure during earthquake

3-12-1-1-Overview

In seismic design of structures that are in contact with water, dynamic pressure of water during earthquake should be taken into account; this pressure is a result of two factors: inertia force that corresponds to the

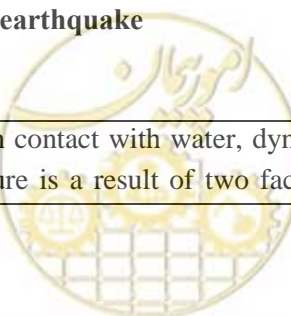

acceleration of the structure, and secondary dynamic pressure caused by the vibration in the surface water.

3-12-1-2-Distribution of dynamic pressure of water in tanks

1-Circular water tanks

Distribution of dynamic pressure of water in relation to the environment and in the direction of water depth during earthquake is expressed as $p(\theta, z_1)$ in terms of (kN/m^2).

$$\begin{aligned} p(\theta_a, z_1) &= K_{SH} \cdot \gamma_0 \cdot \alpha_1 \cdot \cos\theta_a \cdot \sum_{i=0}^{\infty} \frac{(-1)^i}{\lambda_i} \cdot I^{(i)} \left(\frac{\alpha_1}{h_1} \right) \cdot \cos \left(\lambda_i \frac{z_1}{h_1} \right) \\ &= K_{SH} \cdot \gamma_0 \cdot \alpha_1 \cdot \cos\theta_a \cdot I \left(\frac{z_1}{h_1} \right) \end{aligned} \quad (3-24)$$

Where:

γ_0 : water unit weight (kN/m^3)

h_1 : depth of water in the tank (m)

α_1 : internal diameter of the tank (m)

z_1 : coordinate in relation to the tank inner floor. It is assumed to be zero at the beginning and then positive towards the top. (m)

θ_a : Counterclockwise angle in relation to the direction of acceleration.

$$I^{(i)} \left(\frac{\alpha_1}{h_1} \right) = \frac{2}{\alpha_1} \cdot \frac{I_1 \left(\lambda_i \frac{\alpha_1}{h_1} \right)}{\lambda_i I_0 \left(\lambda_i \frac{\alpha_1}{h_1} \right) - \frac{h_1}{\alpha_1} \cdot I_1 \left(\lambda_i \frac{\alpha_1}{h_1} \right)} \quad (3-25)$$

$$\lambda_i = \frac{2i+1}{2} \pi = \frac{\pi}{2}, \frac{3}{2} \pi, \frac{5}{2} \pi, \dots$$

I_0, I_1 : type one Bessel functions, so that we have:

$$I \left(\frac{z_1}{h_1} \right) = \sum_{i=0}^{\infty} \frac{(-1)^i}{\lambda_i} I^{(i)} \left(\frac{\alpha_1}{h_1} \right) \cos \lambda_i \frac{z_1}{h_1} \quad (3-26)$$



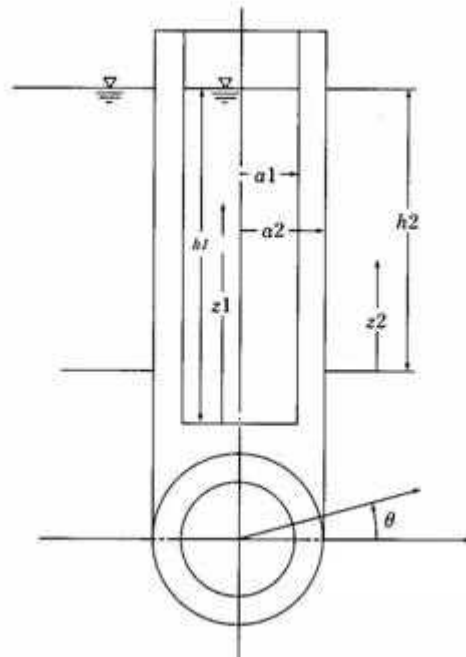

Figure 3-2: circular water tank

2-Rectangular water tank without open surface

If distribution is done in relation to the depth and in line with the width of the tank, dynamic pressure of water, P , in unit wall surface is as follows.

$$p = K_{sh} \cdot \gamma_0 \cdot \frac{B}{2} \quad (\text{kN/m}^2) \quad (3-27)$$

This is in fact the concept of the dynamic pressure of water in unit wall surface. The associated relation is as follows:

($B/2 \times H$ actual mass)

($H \times 1$ passive earth pressure) (3-28)

Therefore, the retaining wall receives the dynamic pressure of water running ahead and behind as follows:

$$p = K_{SH} \gamma_0 \left(\frac{B}{2} + \frac{b}{2} \right) \quad (3-29)$$

3-Rectangular water tank with open surface

$$p(z) = \beta \cdot (7/8) \cdot \gamma_0 \cdot K_{SH} \cdot \sqrt{h_w z} \quad (3-30)$$

Where:

$p(z)$: Dynamic pressure of water (kN/m^2) exerted on the wall surface (one side) in unit width.

z : coordinates of the specific point towards the bottom from the water surface

β : Land correction coefficient that is obtained from Table (3-6).

h_w : water depth



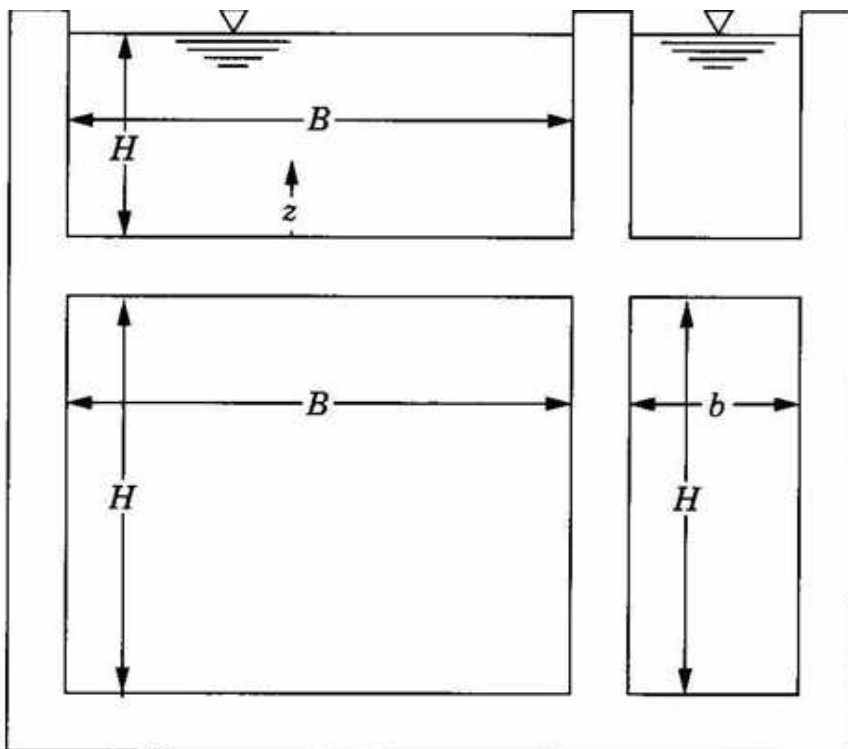

Figure 3-3: rectangular water tank

If the value of B/H is not given, its value will be determined by linear interpolation.

Table 3-6: land correction coefficient

B/H	β
0/5	0/397
1/0	0/670
1/5	0/835
2/0	0/921
3/0	0/983
4/0	0/996
∞	1/000

4-Dynamic pressure of water caused by vertical displacement (up and down)

When open water surface is not available, the associated relation will be similar to relation (3-31).

$$P = K_{SV} \cdot \gamma_0 \cdot \frac{H}{2} \text{ (kN/m}^2\text{)} \quad (3-31)$$

When open water surface is available, relation (3-32) should be used:

$$P = K_{SV} \cdot \gamma_0 \cdot H \text{ (kN/m}^2\text{)} \quad (3-32)$$

3-12-2-Water turbulence

In seismic design of water tanks, water turbulence in the tanks should be controlled (if needed) using the following methods:

- Response spectrum method based on Housner theory

- The N-enhancement-waves method
- Response spectrum method based on potential theory

If the seismic wave is introduced properly, dynamic response analysis will also be accepted.

1-Based on Housner theory, the range surface wave height (maximum wave height) is calculated using relations 3-33 and 3-34.

$$\eta = \frac{0.408R_t \cdot \coth\left(1.841\frac{H_w}{R_t}\right)}{\frac{g}{\omega^2\theta_h R_t} - 1} \text{ (cm)} \quad (3-33)$$

$$\theta_h = 1.531\frac{S_v}{R\omega} \tanh\left(1.841\frac{H_w}{R_t}\right) \text{ (cm)} \quad (3-34)$$

Where:

- η : the range of surface wave height (maximum wave height) (cm)
- R_t : storage tank radius (cm)
- H_w : height of surface wave (cm)
- g : acceleration due to gravity (cm/s^2)
- ω : angular frequency of wave first mode

$$\omega = \sqrt{1.841\frac{g}{R_t} \tanh\left(1.841\frac{H_w}{R_t}\right)} \text{ (rad/s)} \quad (3-35)$$

S_v : velocity response spectrum

2-The N-enhancement-waves method

Natural period of the first mode of surface waves and ground motion is calculated for n number of waves using the transient response analysis method. Wave height or wave pressure fluctuations are calculated using the shortcut design method. Based on the relation (3-36) the maximum wave height is obtained:

$$\eta = D_{OH} \frac{\omega^2}{g} R_t \cdot (0.837)S(n) \text{ (cm)} \quad (3-36)$$

If $T > 7.5s$

$$\eta = V_{OH} \frac{\omega}{g} R_t \cdot 0.837S(n) \text{ (cm)} \quad (3-37)$$

- T : natural period of the first mode of water turbulence
- D_{OH} : horizontal displacement due to ground vibration (cm)
- V_{OH} : horizontal ground motion velocity (cm/s)

ω, g, R_t, H_w : Coefficients similar to the above coefficients.

$S(n)$: response coefficient. If the sine wave includes n input waves, its damping coefficient will be small

If three waves are input, then $S(3) \cong 3\pi$

It is better to assume a damping coefficient of 5% for liquid contents.

3- Velocity potential theory

Based on the result of the velocity response spectrum (i.e. the input), response wave height is calculated as follows:

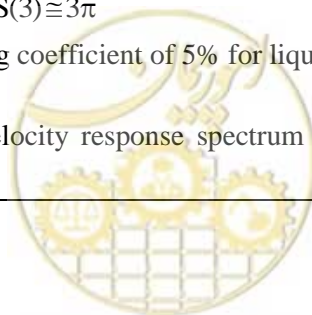

$$\eta_{\max} = 0.245T \cdot \tanh\left(1.841 \frac{H_w}{R_t}\right) S_v \quad (3-38)$$

$$T = \frac{2\pi}{\omega} = \frac{2\pi}{\sqrt{1.841 \frac{g}{R_t} \tanh\left(1.841 \frac{H_w}{R_t}\right)}} \text{ (S)} \quad (3-39)$$

H_w : surface wave height (cm)

R_t : storage tank radius (cm)

S_v : velocity response spectrum (cm/s)



Chapter 4

Seismic Design and Safety Control Methods



4-1-Objective

The most important urban water supply system facilities include:

- Basin
- Transmission line
- Treatment pond
- Tanks
- Distribution network lines

Description:

Damages to the intake [of water] at the beginning of transmission lines can prevent flow of water into the transporting system.

Transmission line may be composed of one or a number of pipes of large diameters that are constructed of steel, reinforced concrete, and ductile iron. Transmission line can be a combination of tunnels and pipes. Transmission lines are mainly buried, but in some parts the lines are designed and implemented as on-ground structures. Static effects, or in other words, geotechnical hazards can have the most impact on the transmission lines.

Tanks are classified as elevated, ground, half-buried and completely-buried tanks. All these types of tanks should be utilizable and safe during earthquakes.

Network lines which are distributed as primary lines in main roads and secondary lines in secondary roads are of very large lengths from hundreds to thousands of kilometers in cities. Steel and polyethylene pipes, which are connected by welded joints, and other types of pipes especially ductile iron and concrete pipes are constructed in segments and are connected using mechanical connections.

4-2-Seismic design process

4-2-1-Seismic design principles

Water supply system components are designed using the allowable stress or the plastic design methods based on the desired risk level.

The allowable stress method is used when risk level 1 is employed. When risk level 2 is employed, seismic design is carried out using the plastic design method.

Description:

1-In the allowable stress method the stress within the [structural] members should not exceed the allowable limits. Otherwise, irreversible deformations will stay with the members even after earthquakes.

2-In designing using the plastic design method the amount of elastic deformations in the members should be less than the amount of allowable elastic deformations. In this case, if the equipments malfunction, their performance should be restored in the shortest time.

4-2-2-Design using the allowable stress method

In order to design water supply components using the allowable stress method the process illustrated in Figure (4-1) is generally followed.

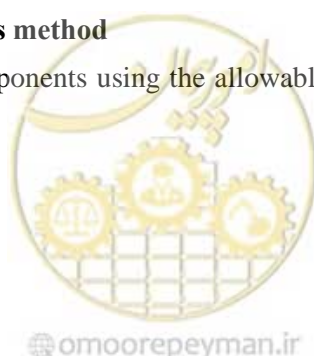

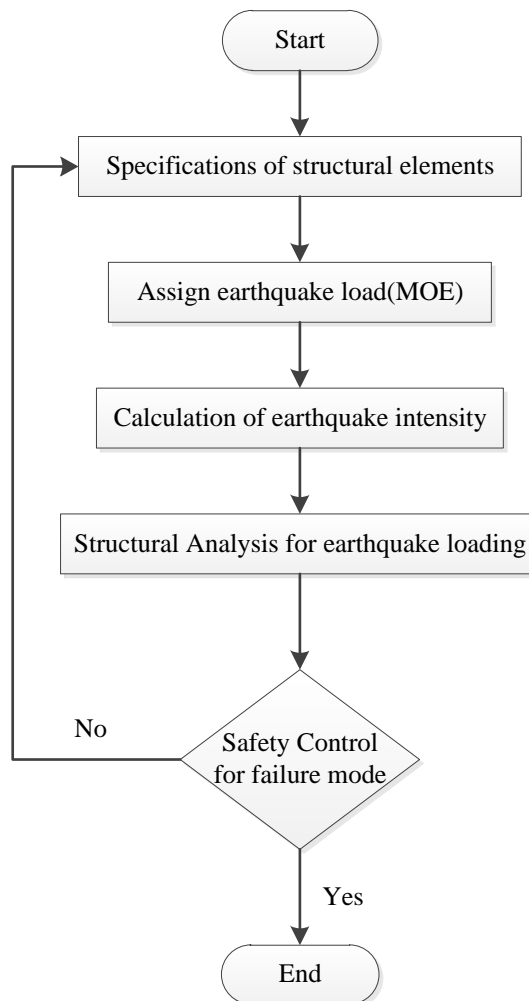

Figure 4-1: Flow of seismic design by the allowable stress method

4-2-2-1-Calculation of design stress

The stress calculated for the structure is the sum of the stresses caused by internal forces, self-weight of the structure, components, and the system load in normal utilization mode together with the stress caused by optimal earthquake in the worst conditions.

4-2-2-3-Evaluation of the calculated stress

If the calculated total stress is less than the corresponding allowable stresses, assessment of seismic performance [of the structure] is acceptable.

4-2-3-Plastic design method phases

In seismic design of water supply system components using the plastic design method the process defined for each of the components will be followed.

4-2-3-1-Risk level for the plastic design method

In the plastic design method risk level 2 is used.

The performance of the structures with seismic design should be consistent with the design seismic force and [resulting] ground liquefaction and displacement.

4-2-3-2-Seismic response analysis

Elasto plastic response deformation is calculated using seismic response analysis. Similar to the response analysis in which non-linear behavior of, for example, elasto plastic deformation is taken into account, the modified quasi-static method using the non-linear concentrated mass model, the modal analysis method using the equivalent linear member model, and the time history analysis method using the elasto plastic member model can also be employed. Among these analysis methods the appropriate response analysis method is selected based on the dynamic non-linear properties of the structure.

Description:

In seismic design of structures using the response analysis method the response plastic deformation ratio is calculated as is described below:

- 1-Energy method
- 2-Equivalent linear response method
- 3-Non-linear response analysis method

1- Energy method

1-1-Ultimate plastic deformation design method

For structures that are under seismic design and their first mode of vibration is dominant, ductility factor can be calculated according to the law of conservation of energy for each of their failure modes.

a) Modification design seismic coefficient

The modified seismic coefficient used in seismic design of structures is obtained from the normalized response magnification factor.

b) Ductility factor

Ductility factor, μ_p , for damaged parts of a structure is calculated using relation (4-1).

$$\mu_p = \frac{1}{4C} \left\{ \left(\frac{K_{MH}}{K_y} \right)^2 - 1 \right\} \quad (4-1)$$

Where:

μ_p : ductility factor of the member associated with the failure mode. If $K_{MH} \geq K_y$ then $\mu_p = 0$

K_{MH} : modified design horizontal seismic coefficient of the structure

K_y : Yield horizontal seismic coefficient of the member associated with the failure mode at the beginning of the yield state. In such cases vertical seismic coefficient should be used in the most critical situations.

C : a constant that its value is defined according to the failure mode.

c) Plastic deformation evaluation

Relation (4-2) must be true in order for the assessment to be carried out.

$$\mu_p \leq \mu_{pa} \quad (4-2)$$



Where:

μ_p : Ductility factor of the member associated with the failure mode.

μ_{pa} : allowable ductility factor

1-2-Yield resistance design method

For framed and foundation structures, plastic deformation design is carried out using the yield resistance method.

a) Modified design seismic coefficient

Its calculation method is similar to what is explained in section 1-1 (A).

b) Structural characteristic coefficient

The structural characteristic coefficient, D_s , is obtained from relation (4-3) or based on the values set in other regulations. D_s must be between 0.25 and 0.5.

$$D_s = \frac{1}{\sqrt{1 + 4C\mu_{pa}}} \quad (4-3)$$

Where:

D_s : structural characteristic coefficient

C : a constant associated with the failure mode characteristics

μ_{pa} : allowable ductility factor of the member according to the failure mode.

c) Seismic capacity

The amount of seismic capacity is calculated using relation (4-4).

$$Q_u = K_y \times W_H \quad (4-4)$$

Where:

Q_u : seismic capacity

K_y : yield horizontal seismic coefficient at the start of the yielding of the damaged member. In such cases, vertical seismic coefficient must be used in the most critical situations.

W_H : service weight of the structure

d) Required seismic capacity

The required seismic capacity is calculated using relation (4-5).

$$Q_{un} = D_s \times K_{MH} \times W_H \quad (4-5)$$

Where

Q_{un} : required seismic capacity

D_s : characteristic seismic coefficient obtained from relation (4-3)

K_{MH} : modified design horizontal seismic coefficient

W_H : service weight of the structure

e) Evaluation of the required seismic capacity

The required seismic capacity, Q_{un} , should not exceed the seismic capacity, Q_u .

2- Linear response analysis assessment

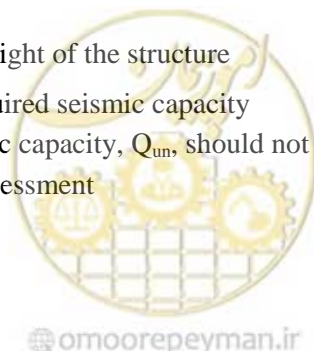

For a member with non-linear behavior and with a capacity more than the yield capacity, linear response analysis can be carried out by reducing the severity of elasticity based on the level of non-linearity and the associated equivalent damping factor.

2-1-Linear modal response analysis

Linear modal response analysis is carried out according to steps (A) to (F) using acceleration response analysis.

a) Design horizontal and vertical acceleration spectra are obtained from relation (4-6).

$$A_H(T) = 700\beta_1\beta_2\beta_3\beta_5 \quad (4-6)$$

$$A_V(T) = 350\beta_1\beta_2\beta_3\beta_6 \quad (4-7)$$

Where:

$A_H(T)$: horizontal response acceleration of natural period T (cm/s²)

β_5 : horizontal response magnification factor (for periods less than 0.3 and 1.5 seconds, and for periods more than 0.3 and 0.75 seconds)

$A_V(T)$: vertical response acceleration of natural period T (cm/s²)

β_6 : vertical response magnification factor (1.5 for skirt-supported towers and 2 for other structures.)

b) Rigidity of the member changes in a nonlinear range based on its stress-strain behavior.

c) The damping factor equivalent to the plastic strain energy, which is obtained from nonlinear response of the structure, can be used.

d) Response value, R, including shear force, moment, acceleration, and design displacement, is calculated using an appropriate mixed method for each mode of vibration.

$$R = \sqrt{\sum_i R_i^2} \quad (4-8)$$

Where:

R_i : response value of the i-th mode

e) Response plastic displacement must be calculated using the response value of the member.

f) Ductility factor obtained in step (E) should not exceed the allowable ductility factor.

2-2-Response analysis using the equivalent load method

Response analysis using the equivalent load method is carried out according to steps (A) to (E).

a) Equivalent load needed for the analysis is determined by an appropriate method. If the structure can be modeled as a single degree of freedom system, equivalent load is calculated by multiplying the member weight by the modified design seismic coefficient.

b) Rigidity of the member changes in a nonlinear range based on its stress-strain behavior.

c) The damping factor equivalent to the plastic strain energy, which is obtained from nonlinear response of the structure, can be used.

d) Response plastic displacement must be calculated using the response value of the member.

e) Ductility factor obtained in step (D) should not exceed the allowable ductility factor.

2-3- Equivalent displacement method

The equivalent displacement method is implemented according to steps (A) to (D).

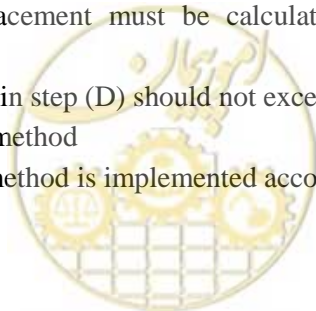

- a) Forced displacement in the bar (bearing) should be equal to the response displacement of the supporting structure or the displacement induced in the foundation as a result of ground motion.
- b) Rigidity of the member under seismic design declines based on a non-linearity level.
- c) Ductility factor is calculated based on the member displacement.
- d) The ductility factor obtained in step (C) must not exceed the allowable ductility factor.

3- Non-linear response analysis

3-1-Time history response analysis

Time history response analysis is carried out according to steps (A) to (D):

- a) Load-ductility characteristics should be defined as a cyclic non-linear model. The results should also be directly obtained from time history analysis.
- b) Application of seismic wave with the maximum acceleration determined for the occurrence point.
- c) Ductility factor is calculated based on the member displacement.
- d) The ductility factor obtained in step (C) must not exceed the allowable ductility factor.

3-2-Static response analysis by the equivalent load method

Static non-linear analysis is carried out according to steps (A) to (E) using the equivalent load method.

- a) The equivalent load is determined through an appropriate method. If the structure can be modeled as a single degree of freedom system, the equivalent load can be calculated by multiplying the member weight by the modified design seismic coefficient.
- b) The modified design seismic coefficient can be calculated using the damping factor which is equal to the plastic strain energy and is obtained from the non-linear response of the structure.
- c) Member displacement is calculated through the static analysis of the model using the non-linear load-displacement relationship.
- d) Ductility factor is calculated based on member displacement.
- e) The ductility factor obtained in step (D) should not exceed the allowable ductility factor.

3-3-Response displacement method

The response displacement method is implemented according to steps (A) to (D):

- a) Forced displacement in the bar (bearing) should be equal to the response displacement of the supporting structure or the displacement induced in the foundation as a result of ground motion.
- b) Member displacement is calculated through the static analysis of the model using the non-linear load-displacement relationship.
- c) Ductility factor is calculated based on the member displacement.
- d) The ductility factor obtained in step (C) must not exceed the allowable ductility factor.

4-2-3-3-Ductility factor

Ductility factor is calculated using the plastic deformation value, which is obtained from the response analysis of the failure mode of the associated equipments during earthquake (vertical and horizontal motions).

Vertical force in a part whose damage may be increased due to structural conditions and failure modes of different facilities is also taken into consideration.

4-2-3-4-Allowable ductility factor

Allowable ductility factor of a member is calculated by considering the plastic deformation characteristics such as fatigue and buckling, and according to the elasto plastic distortions due to low-cycle loading in the worst mode corresponding to the failure mode of the equipment during earthquake.

4-2-3-5-Ductility factor evaluation

If the allowable ductility factor of all the primary members is equal or larger than the desired ductility factor, the seismic performance assessment shall be accepted.

Failure mode and allowable ductility factor is individually determined for each item of equipments.

4-3-Special tips for seismic design of each of the components of urban water supply systems**4-3-1-Intake**

1-The intake valve should be constructed with regard to the possible changes in the river bed and geological and geographical characteristics [of the area].

2-In the junction between the river bed and the intake valve a structure shall be constructed to prevent embankment scouring.

1-The intake valve should be constructed on a location where the water level and the height of the river bed are fixed, and around which no landslide may occur.

2-If the valve is constructed on an unstable location, pile foundations should be employed.

3-Based on the structure, a rigid frame in the transverse section and a cantilever structure in the longitudinal direction will be constructed.

4-The cross section and the reinforcement bar are determined based on the seismic force.

5-Design should be carried out based on the applied loads including loads exerted during uplift of the valve, loads applied by the control panel, and dead loads.

6-Specifications related to the protection of river beds must be met according to the technical criteria associated with waterworks and environmental works in designing intakes.

4-3-2-Collector channel

1-The collector channel should have enough capacity for bearing internal and external stresses. Moreover, in the depth of the channel installation there should be no leakage.

2-If the collector channel is built on an area that is prone to scouring and boiling, a reinforced concrete frame shall be used and the river bed should also be filled with concrete.

4-3-3-Well

1-Seismic calculations for wells should be performed similar to those of the buried pipeline, shaft, conduit and the party channel.

2-If the pumping house for the intake is constructed by reinforced concrete above a deep well, a junction should be placed between the pipe sleeve (bushing) and the transmission line.

3-The junction between the pod and the netting must have sufficient strength.

4-The pipe flexure must have accessories that can be used for emergency distribution of water during earthquake.

5-Resistance of the netting to muddy water or compressive force should be carefully considered.

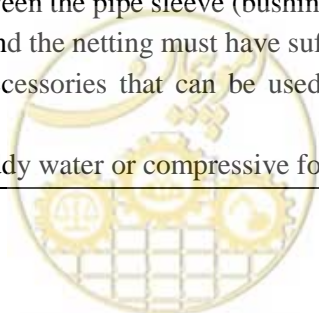

- 1-In order for the vibration of the water pump not to be transferred to sheathed pipe and the horizontal force do not affect the transmission line during earthquake an expansion joint should be placed on the pumping house floor.
- 2-Flexible pipes should be used to connect the deep well to the underground transmission pipe.
- 3-The junction between the pod and the netting must be a welded joint.
- 4-Since shallow underground water is slightly acidic, socket joint shall be employed to the required depth (approximately 30 meters) in the welded point.

4-3-4-Open channel and tunnel

- 1-Seismic calculations for open channels and tunnels should be done using the quasi-static method or the response displacement method and if needed should also be controlled through dynamic analysis.
- 2-Seismic calculations for open channels and tunnel shall be performed similar to those of buried pipelines, shafts, conduits, and common channels.
- 3-In installing the open channel and the tunnel, unstable locations such as the [natural] embankments, artificial embankments, loose grounds, slope upper part, intersections between faults and grounds prone to liquefaction must be avoided.
- 4-Expansion joint must be placed at a proper distance from the open channel and the tunnel.
- 5-The expansion joint and the flexible joint must be placed around structures such as bridges, walkways, valves and on areas with varying ground types.

4-3-5-Buried pond and tank

Types and shapes of water pond structures are determined based on their function.

The inertia force resulting from the weights of water and the tank are calculated using the quasi-static method.

For the buried parts of the pond, forces resulting from the behavior of the soil and its interaction with the pond structure are calculated using the response displacement method.

In this guideline, both of the above methods are covered in the seismic loading of lifelines section.

The design process is explained in chapter 5 based on two methods: the allowable stress method and the plastic design method.

If risk level 1 is employed, the allowable stress method is used; otherwise the plastic design method is employed.

If needed, based on the employer's and the design engineer's judgments the validity of the results can be verified through spectral dynamic analysis or time history analysis according to the related criteria included in Standard 2800.

Seismic design of ponds includes the following components:

- 1-Sedimentation pond
- 2-Mixing pond
- 3-Collection pond
- 4-Precipitation pond
- 5-Filtering pond
- 6-Distribution tank

Chapter 5 covers the seismic design and safety controls for buried ponds such as water treatment ponds and buried water tanks.



For the ease of reference only the word “pond” is used to refer to them.

4-3-6-On-ground and aerial water tanks

Most reservoirs including intake towers, water supply towers, and aerial (elevated) water storage tanks are cylindrical and are constructed of reinforced concrete, prestressed concrete and steel sheets.

Tanks in the refinery also undergo seismic design

Most tank structures are sank within intake towers and above the ground. Therefore, these structures compared to water pond structures are less confined to the ground and are more affected by inertia force.

In addition, these structures are greatly affected by the water contained in the water pond structures.

The effects of water are revealed in the form of hydrodynamic pressure and water surface motion during earthquakes.

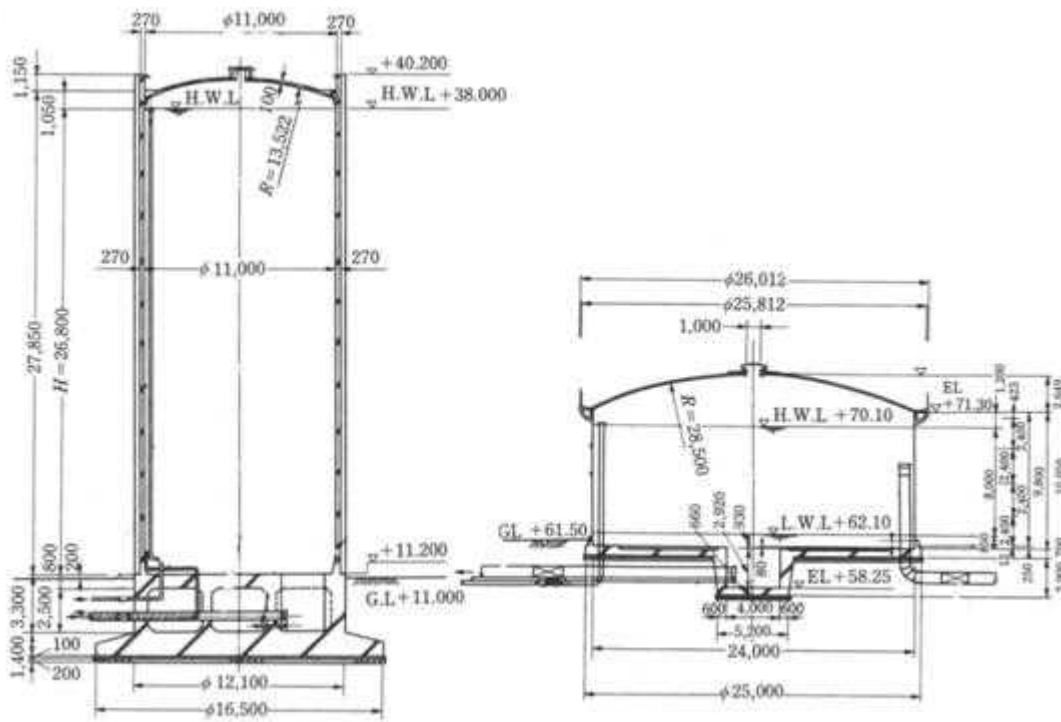

Figure 4-2: A sample on-ground water tank (constructed mainly of reinforce and prestressed concrete)



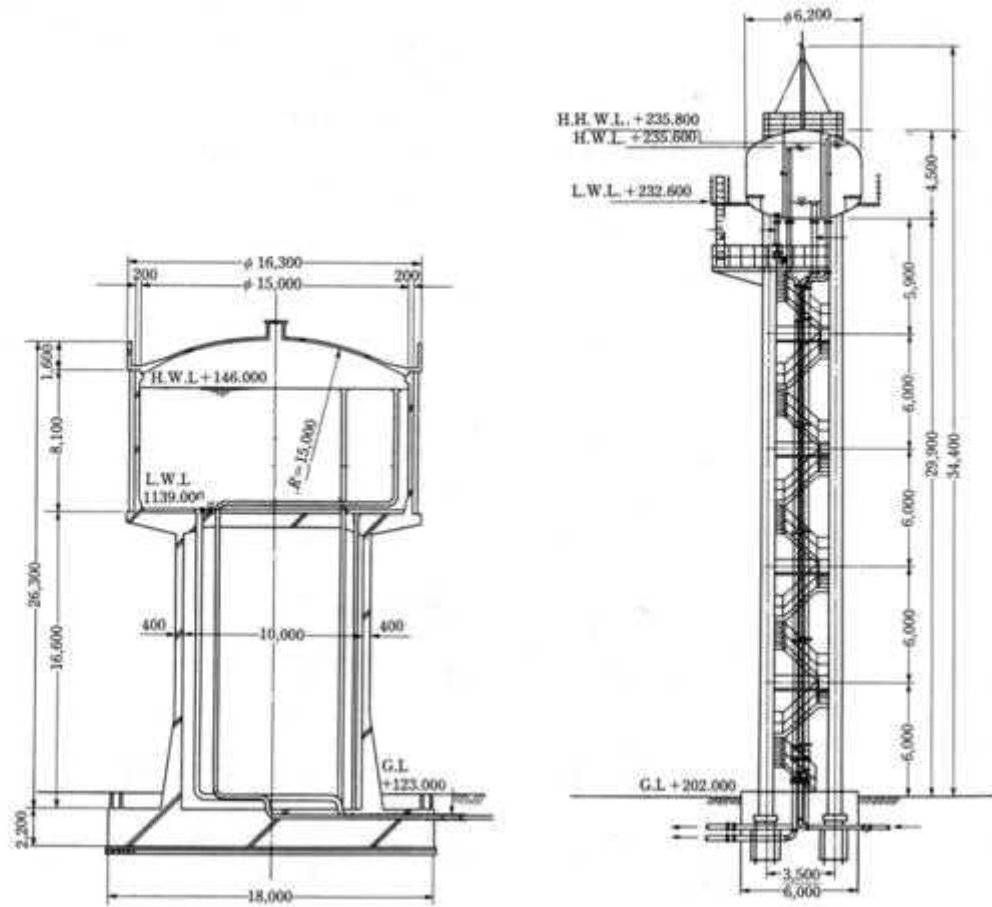

Figure 4-3: A sample aerial tank (reinforced concrete or steel)

4-3-7-Piping

Piping refers to the pipes connecting the equipments in the facilities.

Relative displacement due to different behavior of pipes and equipments is the main purpose for their seismic design.

In order to absorb the aforementioned relative displacement, depending on the situation and process of performance, the required arrangements must be included in the design.

Using flexible shapes is one proper way for absorption of this relative displacement and is common in seismic design.

Using different types of flexible junctions is another appropriate way for preventing too much relative displacement in the junctions between pipes and the equipments. This is also employed in seismic design. Characteristics of these junctions are provided by their manufacturer; otherwise through standard examinations their characteristics can be identified and compared to the characteristics of the displacement under study.

For instance, the design arrangements for some equipments are illustrated in Figures 4-4 and 4-5.



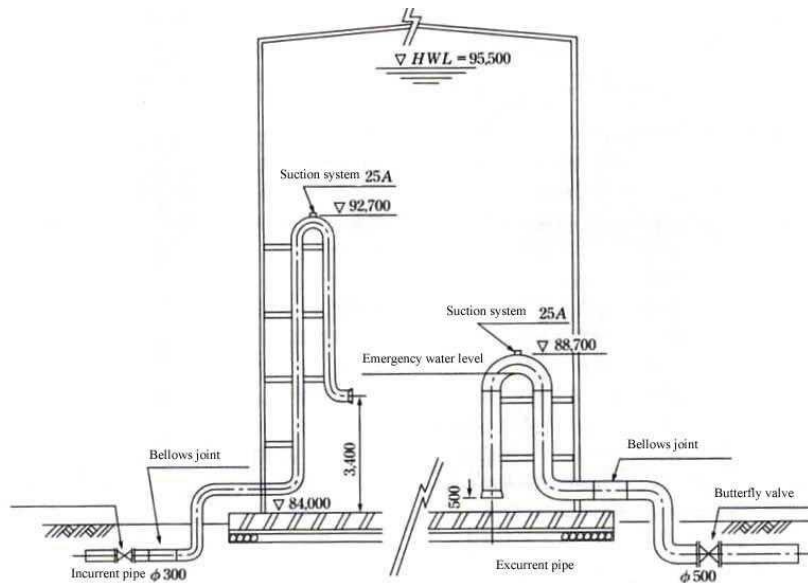

Figure 4-4: Pipes surround a tank

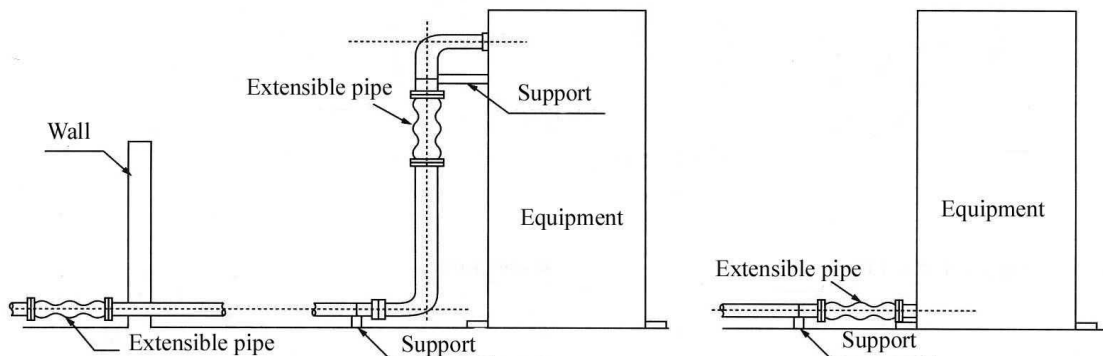

Figure 4-5: Pipes surrounding tanks and equipments

4-3-8-Water supply pipelines

Seismic design of water supply pipelines (transmission or distribution) is carried out in two risk levels based on two limit states:

- 1-To satisfy the serviceability limit state criteria the pipeline should be utilizable without undergoing any damages after an earthquake with risk level 1. The structure must have elastic behavior under such an earthquake.
- 2-To satisfy the ultimate limit state criteria, the possible damages to the pipeline during an earthquake with risk level 2, should be recoverable in the shortest period of time. That is, the structure should not experience rupture or overall failure under an earthquake with risk level 2.

If risk level 1 is used the allowable stress method is employed; otherwise the plastic design method is used for the intended seismic design.

4-3-8-1-Seismic performance of different pipelines

As a general principle, pipeline safety during earthquake must be examined by considering its resistance

and flexibility.

Two types of pipelines are incorporated in water supply facilities:

- Disjoint pipeline: in such pipelines flexibility is rather dependent on connection.
- Unbroken pipeline: in such pipelines flexibility is rather dependent on the aggregates used in the body of the pipelines.

Description:

The seismic calculation method for the main buried pipeline course is explained. Seismic capacity is examined using the response displacement method. This displacement refers to the relative displacements of pipeline and ground.

Disjoint pipelines are usually built from ductile iron and concrete.

Unbroken pipelines are constructed of steel and polyethylene.

Table (4-1) summarizes the primary assumptions for designing disjoint and unbroken pipelines. The amounts of stress for disjoint pipeline components and flexibility capacity of parts are calculated according to the following procedure.

The most important point in seismic design of disjoint pipelines is that the expansion capacity of disjoint pipelines parts that are subject to live loads and normal conditions must not exceed the peak design expansion capacity.

Table 4-1: A review of safety control of pipelines in seismic design

Seismic load	Load conditions	Behavior control	
		Disjoint pipeline	Unbroken pipeline
Risk level 1	Seismic service load + permanent load	Elastic pipe body: pipe body stress \leq allowable expansion stress for each single connection \leq ultimate connection limit displacement absorption capacity	Pipe body stress (elastic mode) < allowable pipe body stress
Risk level 2	Design seismic load + permanent load	Non-elastic pipe body: Pipe body stress \leq ultimate expansion limit stress for each single connection \leq ultimate connection limit displacement absorption capacity	Pipe body stress (plastic behavior) < ultimate limit stress of pipe body

Description:

- If safety against an earthquake with level 2 risks is ensured, safety against an earthquake with level 1 risk should also be ensured.
- The amount of peak expansion is determined based on the connection expansion.
- For welded metal pipes, stress caused by level 1 risk earthquakes must be less than the allowable stress.
- For disjoint pipes in normal conditions, examination of the expansion capacity of connections suffices and there is no need to control body stress.

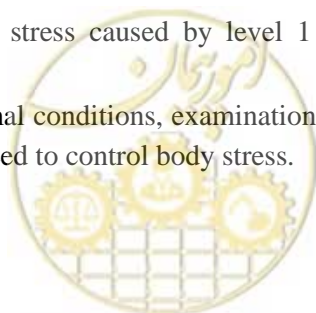

- For unbroken pipes during an earthquake with risk level 1, the stress of body aggregates under live loads must be less than the yield stress of the aggregates.
- The strain corresponding to the yield stress is calculated using relation 4-9:

$$\epsilon_y = \sigma_y / E \tag{4-9}$$

- In risk level 1, in order to retain pipe geometry, pipe strain must be less than 23 t/D percents or approximately (0.15~ 0.2) %.
- In risk level 2, the allowable strain is less than 46 t/D percents or approximately (0.3 ~ 0.4) % considering the amount of idle load that is in fact another expression for allowable stress control.

4-3-8-2-Seismic design of pipelines must be carried out according to the following process:

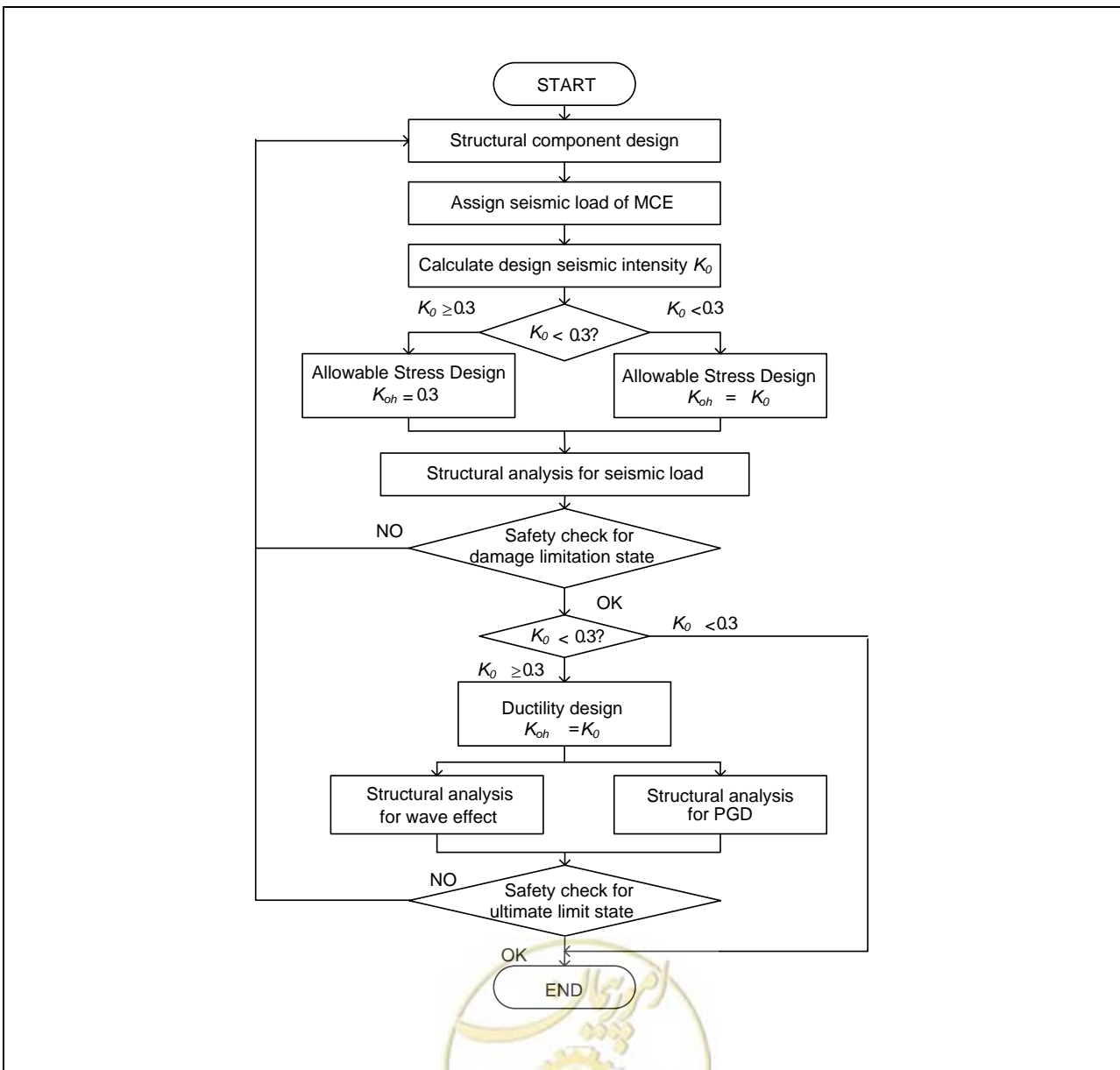

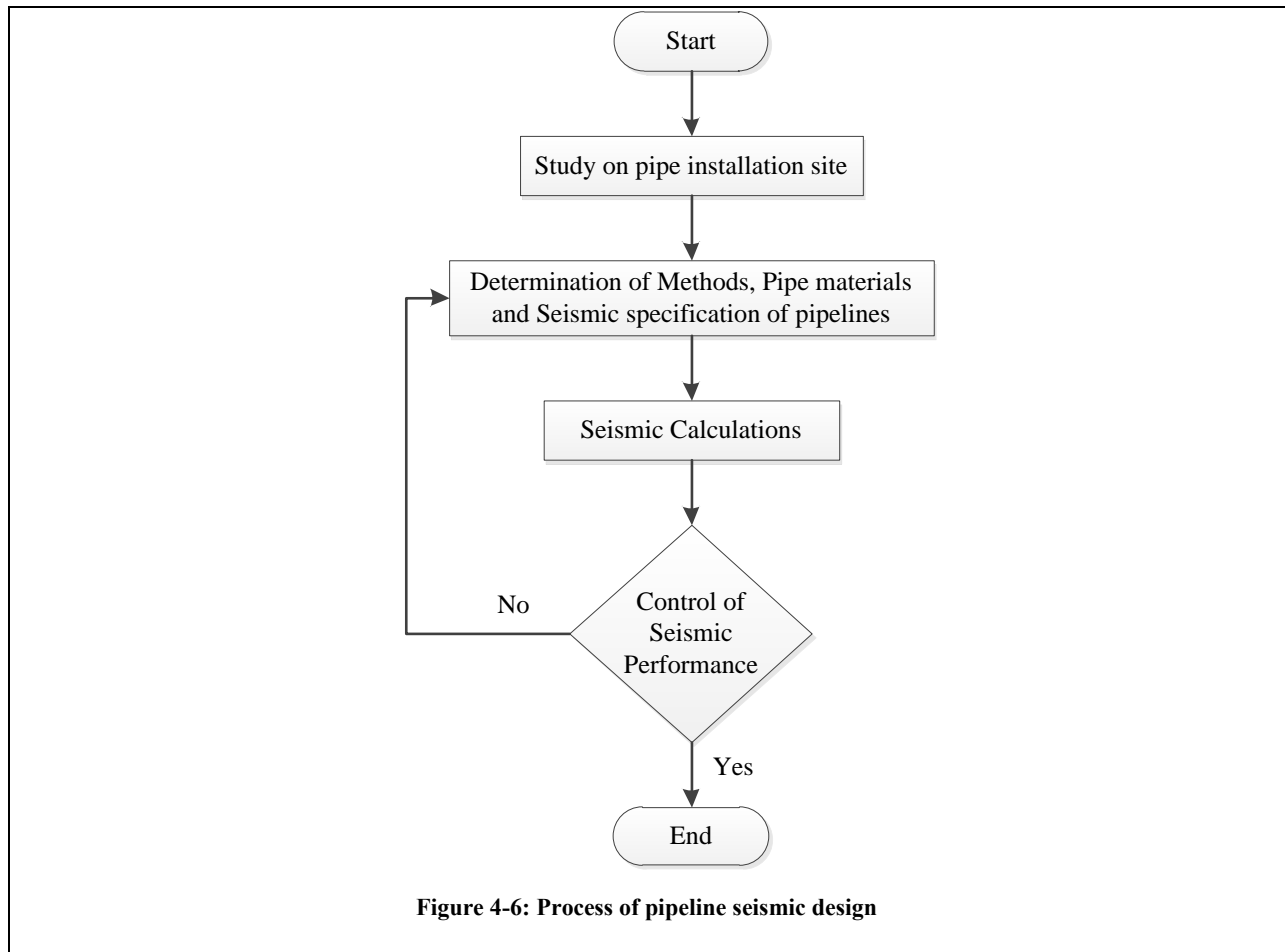

Description:

1-Examination of pipeline installation site

In designing pipelines, examination steps for installation of pipeline in terms of geological, geomorphologic and land use, are as follows:

- a) Site assessment based on the available information and the identified active faults.
- b) Provision of layouts and profiles for different levels of the process of pipe installation.
- c) Provision of a geological map including the N values, soil unit weight, and underground water level
- d) Auditing the geological map based on further exploration (if needed)

2-Geological study

- a) Exploration bores must be drilled to a maximum distance of 100 meters. On problematic grounds these bores must be drilled to less distance and to required depths.
- b) Calculation of dynamic ground magnification factor: the dynamic ground magnification factor must be determined for each layer of earth.

3-Determination of construction methods and pipe aggregates

- a) Choosing the implementation method and pipe aggregates
The implementation method and pipe aggregates are selected according to geological conditions, implementation constraints and the path type.
- b) Determining the number of pipe parts and the required equipments

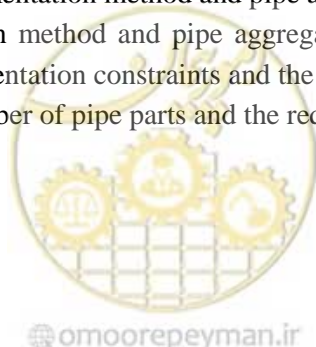

The number of pipe parts and the required equipments are determined based on the desired function.

c) Choosing pipe aggregates, thickness and connection type

Pipe aggregates, thickness and type of connections are selected based on the ground type, implementation method and the desired behavior. Pipe characteristics are defined based on the applied loads including dead and live loads, lateral earth pressure, temperature, unbalancing forces, and earthquake parameters.

4-Seismic calculations

Seismic calculations must be carried out according to chapter seven of this guideline.

The behavior of straight pipes and flexures should be studied separately.

5-Safety control

Safety control is performed according to the desired behavior for the structure.

4-3-8-3-Buried pipelines design phases

- 1-In seismic calculation of buried pipelines, seismic safety is controlled using the response displacement method.
- 2-For disjoint pipes, in addition to expansion and contraction control, circulation of the connections should also be controlled.
- 3-In seismic design of shafts, conduits, common conduits of urban facilities, and bucklers the quasi-static and response displacement methods are used.
- 4-In controlling the stress of pipes bodies, when critical compressive and tensile stresses do exist, compressive stress is considered to be the determining factor.
- 5-In the junctions between the pipelines and the structures and buildings, resulting responses are controlled by dynamic analysis.

4-3-8-4-On-ground pipeline seismic design

Seismic design of on-ground pipelines and their accessories is carried out by assuming the effects of seismic waves based on the following steps:

- 1-If risk level 1 is used; the allowable stress method is used for seismic design.
- 2-If risk level 2 is used; the plastic design method shall be used for seismic design purposes.
- 3-Seismic intensity is calculated according to phase 2 of this guideline.
- 4-Since the effects of inertia force and water dynamic pressure cannot be neglected when water level is high, it is proposed to perform safety checks using the dynamic analysis method after using the quasi-static method.
- 5-For seismic design of structures that have complex behavior under design seismic loads, in order to verify the results of the calculations done using the quasi-static methods or the response displacement method, the dynamic analysis method shall be employed.
- 6-The most important on-ground pipes include bridge-crossing pipes or trough aqueducts that are constructed on piers.

Description:

- 1-Water pipe bridges and trough aqueducts are structures that cross rivers.
- 2-During past earthquakes these structures have been damaged due to the damages to the anchor systems and their stability. Hence, the connections of the piers to the ground or the bridges must be of high strength.

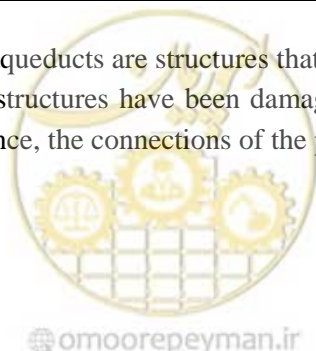

3-Water pipe bridges and trough aqueducts are simple structures with at least 2 modes of vibration.

Therefore, the structures can be designed using the quasi-static method but the dynamic analysis method is only used when the structures have complex behavior.

4-Water pipe bridges and trough aqueducts that need dynamic analysis include:

- Bridges with significant vertical vibrations and periods more than 1.5 seconds, bridges with elevated piers (more than 30 meters), bridges with high vibration modes, and bridges with high displacements.
- The spectrum and time history analysis method can be used for dynamic analysis, selection of which depends on design purposes. Two dynamic models exist: the unbroken pipe mass model, and the discrete pipe mass model. Due to the limited field conditions of the first method the second method is often employed.



Chapter 5

Seismic Design and Safety Control of Treatment Ponds and Buried Tanks



5-Treatment Ponds (and Buried Tanks)

In this chapter seismic design and safety control of buried ponds such as water treatment pond and water buried tanks are covered.

For the ease of reference only the word “pond” is used.

5-1-Seismic calculation method

5-1-1-Overview

Water pond structures are structures that are rather rigid and are constructed of reinforced concrete. In many cases these structures are constructed underground. Therefore, during earthquake these structures are not only are subject to the inertia force resulting from their weight, but also are affected by earth pressure and deformation of their surrounding ground. Seismic design must be carried out using the quasi-static method (for calculation of earthquake-induced inertia force) and the response displacement method (for calculation of interaction force caused by deformation of the soil covering the structure).

5-1-2-Quasi-static method

- 1-Seismic calculations for a highly-rigid pond structure with natural period of less than 0.5 seconds are done using the quasi-static method.
- 2-In this case the inertia force due to the weight of the structure, loading weight and earth pressure during earthquake (direct shearing earth pressure) are taken into account.
- 3-When the pond is buried under the ground, the horizontal seismic coefficient applied to the center of gravity of the structure must be calculated through interpolation of the coefficients regarding the distance between ground level and the bed.
- 4-When risk level 1 is used, there is no need to consider the non-linear behavior of the ground and structure.
- 5-Vertical seismic coefficient is considered to be half of the horizontal seismic coefficient.

5-1-3-Response displacement method

- 1-When the dimensions of the structural section are large and on the other hand the ground in the area has varying characteristics, the distribution form of the response ground motion during earthquake will vary depending on the thickness and characteristics of the surface ground layer.
- 2-In such cases, the seismic forces of displacements during earthquake and spring constants between the ground and the structure are calculated and the results are used in evaluation of sectional area forces and structural stresses.
- 3-The extent of ground displacement must be calculated.
- 4-When risk level 1 is used, there is no need to take the non-linear behavior of the ground and the structure into consideration.

5-1-4-Dynamic analysis

For a pond structure with large dimensions and a high level of importance, in addition to the quasi-static method and the response displacement method, dynamic analysis should also be carried out.

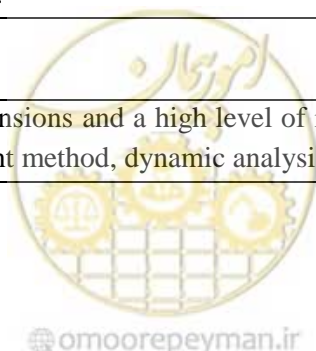

5-1-5-Calculation modeling

The ground and structure must be modeled properly based on the type, scale, and characteristics of the structure and the site soil.

Description:

- Structural models include the rigid frame model, the cap model, the hybrid model (beam and shell model), the mass-spring model, the 2D and 3D FEM models, etc.
- In order to model the dynamic ground behavior, limited parts 2D or 3D methods especially using the thin-layer element can be employed.
- In modeling the ground and structures: if risk level 1 is employed, generally there is no need to include non-linear behavior of the structure aggregates and the ground though non-linear behavior of the aggregates should be properly considered in other cases.

5-2-Effects of earthquake

In seismic design of a pond structure the following issues shall be taken into account:

- 1-Inertia force due to dead load of the structure, etc.
- 2-Ground displacement or deformation during earthquake.
- 3-Earth pressure during earthquake.
- 4-Hydrodynamic pressure during earthquake.
- 5-Vibration of water surface (water turbulence).
- 6-Liquefaction and lateral spreading.

Description:

1-Inertia force

Soil coatings in the site should be taken into account in the evaluation of the inertia force resulting from the structure weight and the loading weight.

Each weight must be multiplied by the seismic coefficient in general. When the structures are buried into the ground (such as water tanks) in addition to the earth pressure around the structure during earthquake, the inertia force resulting from friction of the surrounding soil should also be considered as well.

2-Ground deformation

Most of pond structures are constructed as half-buried or completely buried structures. Hence, it is anticipated that they will be affected by a ground response during earthquake.

For seismic design purposes of these structures, the strain and stress caused by ground deformation must be calculated for them.

Seismic design of structures in sites with complex topologic and geologic conditions and varying physical characteristics must be carried out with more precision, because in such cases the effect of earthquake on the buried structures increases significantly.

Displacement and deformation on soil adjacent to the structures are calculated using the response displacement method and dynamic analysis.

3-Earth pressure

Earth pressure during earthquake can generally be calculated using the relations introduced in chapter three.

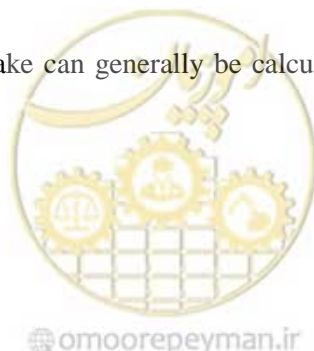

The available data and the experiments suggest that assuming that a large earthquake occurs, the adjacent ground [to the earthquake epicenter] – as is expected based on the relations- will not reach the ultimate state and distribution of earth pressure also differentiates from it slightly. In such cases earth pressure during earthquake is evaluated by increasing the dynamic response which is obtained by multiplying the relative displacement between the structure and the ground by the spring constant.

4-Hydrodynamic pressures and water turbulence

Hydrodynamic pressures due to inertia force and water turbulence must be calculated and added to the water static pressure using the relations introduced in this guideline.

Water surface vibration in large ponds and sloped sedimentation ponds should also be controlled.

5-Liquefaction and lateral spreading

When the ground is sloped or the possibility of liquefaction and lateral spreading of the soil along the embankments and rivers exists, these effects are needed to be controlled with regard to liquefaction-induced ground horizontal movements.

6-Figure (5-1) shows an example of loads exerted on tank walls in empty and full modes of the tank.

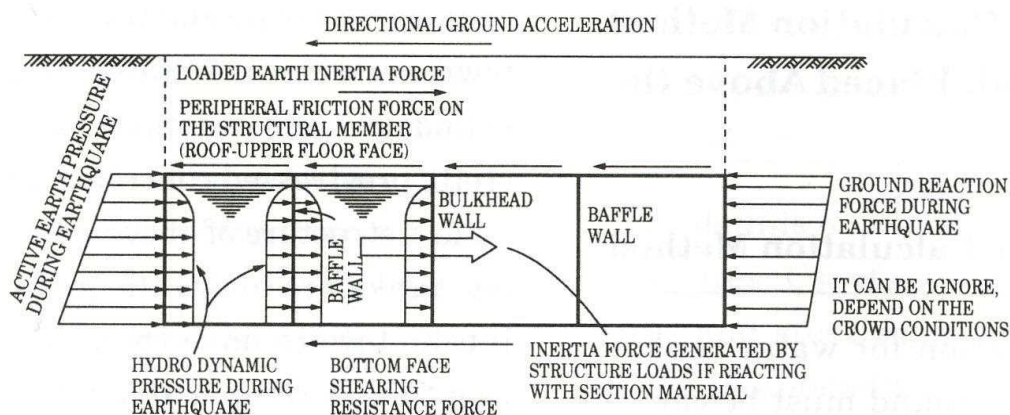

Figure 5-1: Sample seismic load (from one side of the tank on/ the other empty side of it)

5-3-Seismic input

5-3-1-Seismic coefficient

Coefficients below are calculated based on the quasi-static method introduced in this guideline under the title of Seismic Loading on Lifelines:

- ✓ Horizontal seismic intensity, K_H
- ✓ Vertical seismic intensity, K_V
- ✓ Horizontal seismic coefficient, K_{SH}
- ✓ Vertical seismic coefficient, K_{SV}

These coefficients are to be used in the calculations in this chapter.

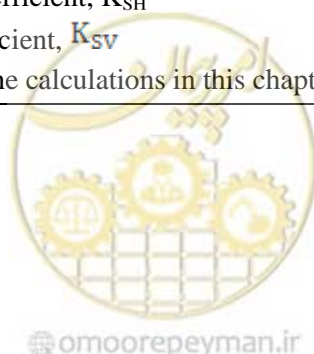

5-3-2-Ground horizontal displacement by response displacement method

For seismic design of buried structures the response displacement method must be employed. Range of ground displacement, U_h , at a depth of x (m) from the ground level is obtained from the relation given in this guideline under the title “Seismic Loading on Lifelines” in the section related to the response displacement method.

5-3-3-Ground period

Ground period is calculated using relation 5-1.

$$T_G = 4 \sum_{i=1}^n \frac{H_i}{V_{si}} \quad (\text{s}) \quad (5-1)$$

Where:

T_G : Ground period (s)

H_i : thickness of i -th layer (m)

V_{si} : Elastic shear wave mean velocity (m/s)

-Velocity of elastic ground shear waves in layers is measured using an elastic wave and the SPT test.

-When previous measurements are not available, velocity of shear wave can be obtained from the N value in Table (5-1).

Table 5-1: Velocity of ground elastic shear wave

Periodic sediments		V_s (m/s)		
		10^{-3}	10^{-4}	10^{-6}
Old alluvial	Clay	$129N^{-0.183}$	$156N^{-0.183}$	$172N^{-0.183}$
	Sand	$123N^{-0.125}$	$200N^{-0.125}$	$205N^{-0.125}$
Alluvial	Clay	$122N^{-0.0777}$	$142N^{-0.0777}$	$143N^{-0.0777}$
	Sand	$61.8N^{-0.211}$	$90N^{-0.211}$	$103N^{-0.211}$

Note: Classification is done with a 100% combination ratio of sand and clay soil for soils and shear strain level of 10^{-3} and 10^{-6} for foundations.

5-3-4-Earth pressure

In order to calculate earth pressure, see section 3-11.

5-3-5-Hydrodynamic pressure

In order to calculate hydrodynamic pressure, see section 3-12.

5-3-6-Turbulence

In order to calculate water turbulence see, section 3-12-2.

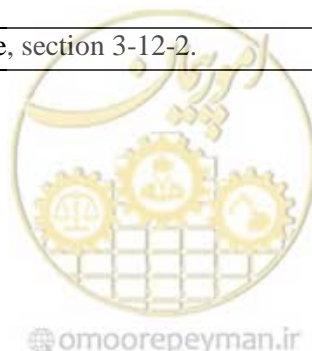

5-4-Load combination

In seismic design of ponds the following load combinations must be taken into account:

- 1-Live load
- 2-Dead load
- 3-External pressure (earth pressure, water pressure, flotation, interaction)
- 4-Internal pressure (water pressure)
- 5-Inertia force

Table 5-2: Load combinations for pond facilities

Status	Normal	Earthquake
Full of water with external pressure	(1), (2), (3), (4)	(1), (2), (3), (4), (5)
Empty with external pressure	(1), (2), (3)	(1), (2), (3), (5)
Full of water	(1), (2), (4)	(1), (2), (4), (5)

5-5-Structural considerations

For seismic design of ponds the following structural considerations shall be taken into account.

- 1-A pond without open water surface must be safe against hydrodynamic pressure, control and proper arrangements.
- 2-A pond with expansion joint shall be controlled (treated) as a shearing wall.

1-Closed pond without open water surface

- In closed ponds that are under pressure (such as multi-layer ponds with no open water surfaces) vertical movement is controlled and hydrodynamic pressure is increased. In such cases, the hydrodynamic pressure of horizontal and vertical components must be controlled.
- According on theoretical analyses, hydrodynamic pressure of a closed pond will increase with an increase in its width.
- As it can be seen in Figure (5-2), as one of the arrangements to be made, the pond located below the multi-layer pond is divided into multiple small parts and the related hydrodynamic pressure also decreases.

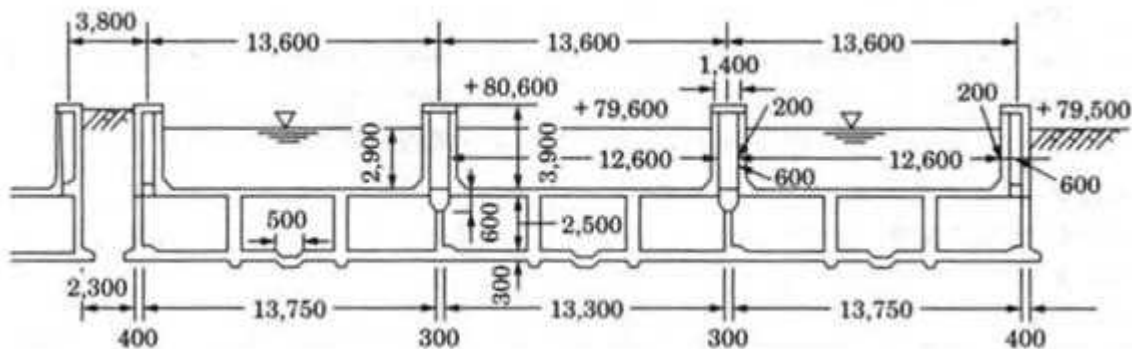

Figure 5-2: A sample multi-layer pond

2- Expansion joint

A pond is a structure that is usually covered with soil. During earthquake horizontal earth force is affected by earth.



Since lateral shearing force in a rectangular pond without an expansion joint is transferred to the floor via the side walls, there is no need to build a shear wall.

Since a rectangular pond with an expansion joint is subject to torsion caused by lateral shearing force, to avoid this condition a shear wall shall be used.

Using a current control wall as a shear wall is useful because this type of wall is not affected by torsion.

The shear wall must be designed according to the guideline for concrete structures.

- ✓ The shear wall subjected to horizontal force shall be designed using the ultimate limit method.
- ✓ The column adjacent to the shear wall must be designed as a structure with a rigid frame.

For safety control of the shear wall when the beam model is used in designing the wall connected to the rigid frame, it is essential to consider the seismic performances, rigidity of the walls and their adjacent columns, load transmission conditions and failure mechanisms.

For this purpose, as it is illustrated in Figure 5-3, wall models can be designed in such a way that the first model contains one column, the second contains one wall and the third contains a bracing instead of the wall.

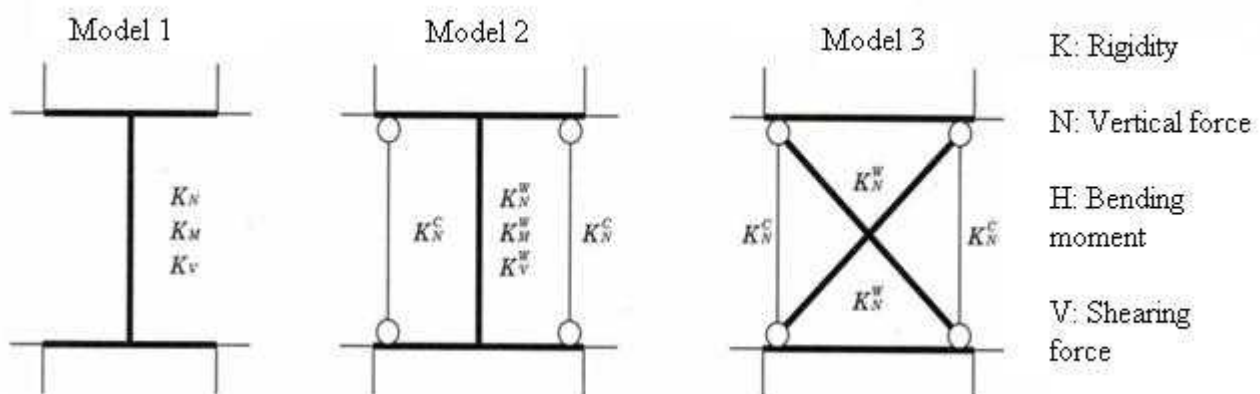
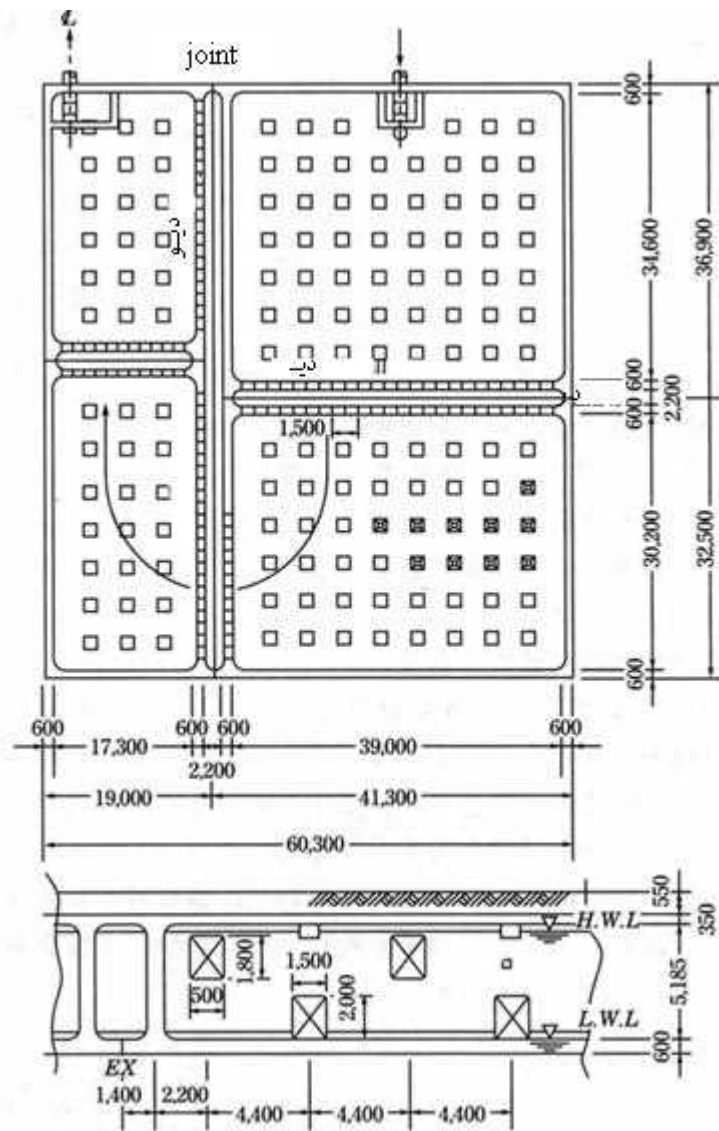

Figure 5-3: the triple models for using beam element as shear wall

- In the side wall, shear wall, and the column that are designed for bearing the seismic shear force, adequate number of horizontal and ring bars must be installed in order to provide tension in the diagonal direction.
- For designing walls see issue 123.
- Figure (5-4) shows a shear wall that is installed along the expansion joint in the whole section.





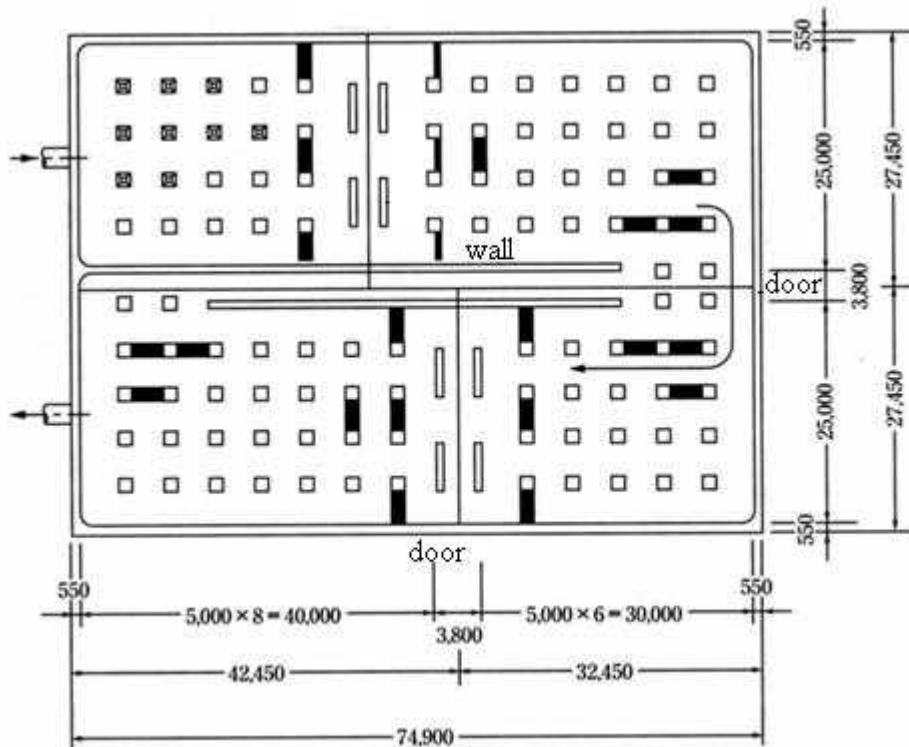

Figure 5-4: A sample pond with interior shear walls

5-6-Operational details for safer performance during earthquake

For having safer performance during earthquake the following considerations shall be taken into account in seismic design of ponds:

- 1-The difference between the sectional areas of pond facilities should be great. The corner of the pond should also have backing.
- 2-Regardless of the fact that the expansion joints absorb deformations caused by temperature and earthquake, these joints can cause infirmity to the structure. In such cases it is necessary to provide the absorption capacity for the deformation caused by temperature and earthquake in the expansion joints with precision.
- 3-If necessary materials or insulating coatings that are resistant to chemicals and are suitable for waterproofing shall be used.

1-Corner backing

- This part must be reinforced adequately because this part is the center of stress and can be the weakest point in the member and the curves.
- Reaction force is focused on this part and its sectional area and suddenly changes performances of the members such as the overall middle beam anchor, columns, foundation, caps and walls.

2-Expansion joint

- Expansion joints are used for preventing the emergence of shrinkage cracks after casting concrete, avoiding absorption of expansions caused by temperature changes,



concentration of stress in the junctions between the structure and other structures, and in the concrete preparation site.

- The spot of the expansion joint can be considered as the weakness spot of the whole structure. But in order for the structure to be water proof and installable on a soft bed, arrangements must be made to absorb adequate amount of the expansion that is caused by relative displacements during earthquake.
- In general, the expansion joint is placed at distances of 20 to 30 meters. Expanding cement can be used to increase distances.

3-Concrete

- The pond structure must be designed based on the characteristics of concrete structures.
- In the construction phase issues such as water penetration from the concrete cracks, corrosion of reinforced concrete, infirmity of the ground under the distributed foundation, and unbalanced leakage of underground water shall be taken into consideration.
- If the side walls of large-scale ponds are constructed of mass concrete, the possibility of thermal cracks caused by hydrated heat does exist.
- Choosing the types of aggregates and the mix design, the manner of installation of reinforced bars to prevent an increase in crack width, and installation of false joints are of great importance.
- One of the advantages of installing false joints is that by employing these joints the waterproofing capacity is enhanced along with the thickness of the side walls; also the performance and repair precision at the spot of false cracks, which are created in random directions and have V shaped sectional areas, is increased as well.
- Criteria and standards of crack widths are included in issue 123.
- Since the position and direction of construction joints leave significant effects on resistance of the building, it is better to install construction joints in perpendicular direction in relation to compressive forces where shear force is small.
- In the junction between the column head and the beam, it is better to install the expansion joint above the column by considering [future] concrete slumps.
- Since the construction joints are considered to be points of weakness in corrosion of reinforced concrete, it is better to avoid installing it in places into which corrosive materials can easily penetrate.
- In cases where liquefying material is mixed with concrete in order to prevent cracking, increase air permeability properties and waterproofing properties, reduce heating capacity of mass concrete casting, and enhance constructions, segregation can be easily done by a significant increase in the slump or a decrease in the amount of very small particles.
- Changes in the slump increase in relation to time and decrease in relation to air content.
- In making liquefied concrete, the type of aggregates, the mix design, and the type of liquefier used in the concrete are examined in order to ensure the quality of the concrete.



- Since the amount of concrete and bar corrosion under the effect of additives such as chlorine and aluminum sulfate can be significant, it is better to cover the inner side of the pond by reinforced concrete with a thickness of at least 10 centimeters.
- If the walls of the pond are waterproofed, the aforementioned thickness can be between 5 and 10 centimeters.
- About other essential characteristics considerations below are introduced:
 - ✓ A structure composed of beams, columns, caps and walls should be analyzed as a framed structure.
 - ✓ Frame corners must be reinforced.
 - ✓ Arrangement of reinforced concrete in the corners must be done based on the concrete junctions.
 - ✓ The Stirrup next to the beam-column junction must be in shape of a ring with close steps.
 - ✓ The least distance between the bars should be equal to the least distance needed for proper concrete casting around the tensile bars.
 - ✓ Resection of the bars should be performed step by step.
 - ✓ Additional reinforced bars should also be employed because tensile steel bars put stress on the concrete while they are placed in the inner corner of rigid frames.
 - ✓ In sectional areas with dimensions larger than one meter, the central ring bar should be arranged in a way that it can prevent buckling of the axial steel bar.
 - ✓ The steel bar should not be connected with high stress at the junction spot.
 - ✓ The corners of concrete members must be miter cut to prevent corrosion of concrete especially when it is affected by cold and variable weather.
 - ✓ To prevent cracking due to temperature changes and concrete shrinkage, minimum or thermal bars shall be employed.
 - ✓ To boost the structure and prevent cracking and stress concentration, bars should be placed adjacent to the exit points of caps and walls.

4-Sheets resistant to chemicals and seals

- In order to prevent penetration of water and chemicals (such as chlorine, aluminum sulfate and ozone), seals should be built within the inner concrete with epoxy resin.
- If plastic or mortar is used to create coating, construction conditions including application goal and concrete casting operations shall be taken into account.



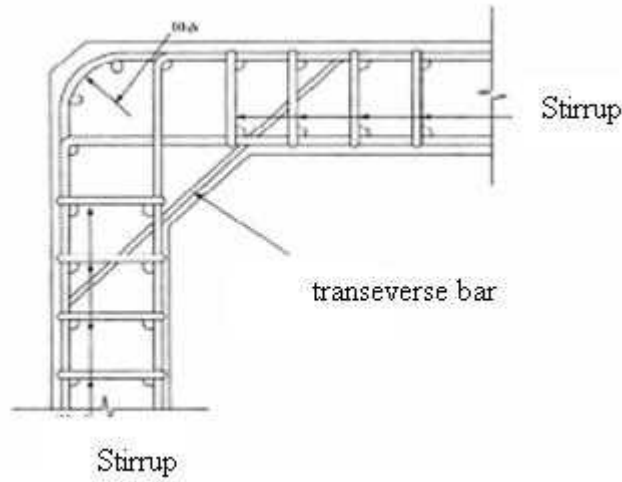

Figure 5-5: Arrangement of reinforced bar in the corner of a concrete pond

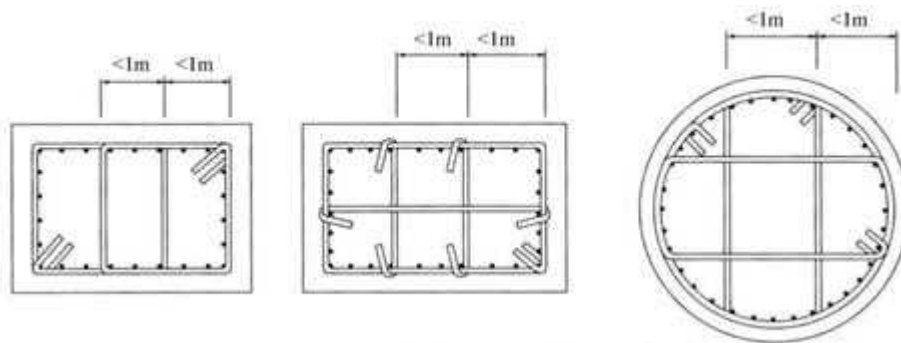

Figure 5-6: Sample arrangement for reinforced concrete in large sectional areas

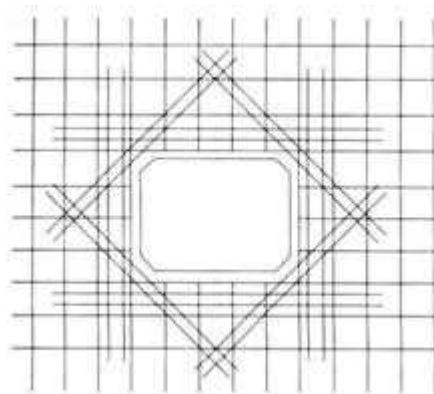

Figure 5-7: Sample arrangement for reinforced bar around the casement frames

For more detailed information on the manner of implementation of reinforced concrete see under the ninth topic of the national building code and Iranian concrete regulation that is included in issue 123.



Chapter 6

Seismic Design and Safety Control of On-Ground and Aerial Water Tanks



6-1-On-ground tanks

6-1-1-Seismic calculations method

Seismic calculations for on-ground tanks should be carried out based on the shape, characteristics and size of the structure as a whole or partially.

Usually the quasi-static method is used for seismic calculations of on-ground tanks. When seismic coefficient is large the design equivalent seismic coefficient shall be determined based on the ground type and natural period of the structure.

Most on-ground tanks are cylindrical shell structures with thin walls. Deformation of these tanks can be almost similar to deformation of the shearing system or shear-bending system in beams. Therefore, analyzing the model as shear beams is necessary. The size of the model depends on the size of the structure. Models include 5 to 10 proper concentrated masses. Analysis of the seismic response of shells is not necessarily enough. Therefore it is suggested to analyze water tanks as a model of shear beams with a concentrated mass system (Figure 6-1).

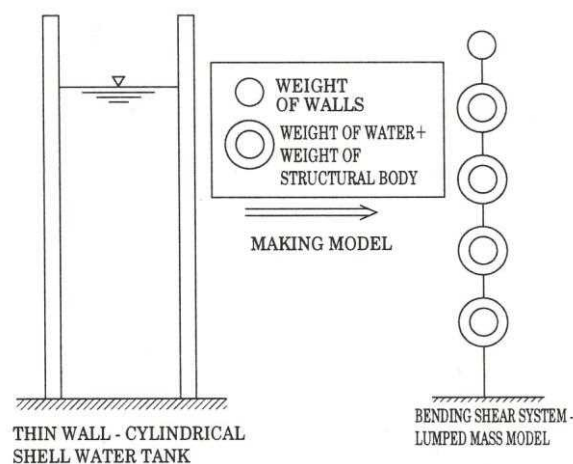

Figure 6-1: Dynamic analysis model

External forces in the shell model are calculated by the mass response of each point. In analyzing the model of water tanks (as bending shear beams), the masses of the points are taken into consideration. Analysis of the shell is carried out using the quasi-static method in which external forces are incorporated.

The following two analysis modes are acceptable:

- Modal analysis using the standard response spectrum or several response spectra of famous seismic waves.
- Analysis using the direct integral of seismic waves, in which shapes of several famous seismic waves are used.

Choosing the response spectrum or the particular input seismic wave through direct integration should be based on the seismic characteristics of the ground on which water tanks are constructed.

6-1-2-Quasi-static method

Earthquake force is calculated by multiplying the weight coefficient by the seismic coefficient and is

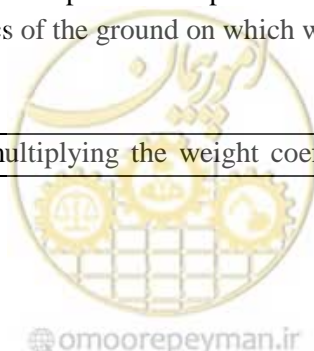

applied to the center of gravity of the structure.

6-1-3-Equivalent seismic coefficient method

1-In this method the design horizontal seismic coefficient is calculated by multiplying the standard horizontal seismic coefficient by the characteristic coefficient of the structure, C_s .

2-Seismic intensity and the design seismic coefficient can be calculated according to the section titled Seismic Loading of Lifelines of this guideline.

3-Characteristic coefficient of the structure is calculated using relation 6-1.

$$C_s = D_h \cdot D_\eta \quad (6-1)$$

Where:

D_h : modification coefficient of damping coefficient of the structure

$$D_h = \frac{\sqrt{5}}{\sqrt{h}} \quad (6-2)$$

Where

D_η : reducing value that is determined based on plastic deformation capacity, which is obtained from relation 6-3:

$$D_\eta = \frac{1}{\sqrt{1 + 4\eta}} \quad (6-3)$$

Where

$$\eta = \frac{\delta_0}{\delta_y} \quad (6-4)$$

Where

η : mean cumulative rate of plastic deformation

δ_0 : cumulative plastic deformation (unit length)

δ_y : yielding displacement (unit length)

The units of δ_0 and δ_y must be alike.

For tanks that are directly constructed on the ground, the value of C_s differs depending on the type of the structure and it can be obtained from Table 6-1.

Table 6-1 value of C_s

Structure type	C_s
Reinforced concrete	0.45
Miscellaneous steel tank	0.55

Description:

In the case of prestressed concrete the value of C_s can be equal to one.

If the characteristics of the structure are analyzed clearly the obtained values will be usable.

When the movement of the structure is complex during earthquake dynamic analysis should be carried out if necessary.



6-1-4-Analytic model

The ground and the tank should be modeled properly based on the type, shape and characteristics of the structure and the setting and ground surrounding the structure.

Among structural models we can refer to the cap model, the cylindrical hybrid model (beam and shell model), the mass model, and the 2D or 3D FEM models.

Models including the thin layer element model and the 2D or 3D FEM models can be used for modeling grounds.

Linear analysis is carried out in the quasi-static method without the need to consider the non-linear behavior of ground aggregates and the structure.

In the plastic design method the non-linear behavior of the structure and ground aggregates shall be also considered.

6-1-5-Effects of earthquake

The following considerations shall be taken into consideration for seismic design of tanks:

- 1-Inertia force caused by dead load of the structure, etc.
- 2-Hydrodynamic pressure put on faces of the structure during earthquake.
- 3-Hydrodynamic pressure put on the interior and exterior faces of the walls of a water tank.
- 4-Water surface vibration (turbulence)

Stress, deformation and stability of the structure shall be examined for cases when the tank is full of water, is empty or is half-filled.

6-1-6-Seismic input

6-1-6-1-Design seismic coefficient

Coefficients below are calculated using the quasi-static method that is explained in this guideline under the title of Seismic Loading of Lifelines:

- ✓ Horizontal seismic intensity, K_H
- ✓ Vertical seismic intensity, K_V
- ✓ Horizontal seismic coefficient, K_{SH}
- ✓ Vertical seismic coefficient, K_{SV}

These coefficients will be used in the calculations of the consequent sections of this chapter.

6-1-6-2-Design period of on-ground tanks

The period used in calculations of on-ground cylindrical water shell tanks is as follows for different cases:

1-Empty tank period

$$T = \frac{\pi \cdot I^2}{a} \cdot \sqrt{\frac{2q}{3gE} \left\{ 1 + 12 \left(\frac{a}{I} \right)^2 \right\}} \quad (6-5)$$

2-Full tank period

$$T = \frac{\pi \cdot I^2}{a} \cdot \sqrt{\frac{2q'}{3gE} \left\{ 1 + 12 \left(\frac{a}{I} \right)^2 \right\}} \quad (6-6)$$



$$q' = q + \frac{q_0 \cdot a}{2 \cdot t} \cdot \frac{\tanh\left(\frac{\sqrt{3} \cdot a}{l}\right)}{\sqrt{3} \cdot a} \quad (6-7)$$

3- Stored water period

$$T = 2\pi \sqrt{\frac{a \cdot \coth(0.586\pi \cdot l/a)}{0.586\pi \cdot g}} \quad (6-8)$$

Where:

t : thickness of side walls of tanks (m)

q : wall aggregates density (N/m³)

a : tank radius (m)

l : tank height (m)

q₀ : liquid density (N/m³)

g : gravity acceleration (m/s²)

E : Young's modulus (N/m³)

To calculate the natural periods of tanks, relations similar to those introduced in Standard 2800 or other valid regulations are employed.

6-1-6-3-Earth pressure

When part of the tank is buried into the Earth, for information on calculation of the pressure exerted by soil see section 3-11 of this guideline.

6-1-6-4-Hydrodynamic pressure

To determine the amount of hydrodynamic pressure see section 3-12.

6-1-6-5-Turbulence

To calculate the turbulence in liquids, see section 3-12-2.

6-1-7-Load combinations

The stress resulted from combination of loads must be less than the allowable stress or the allowable stress defined for seismic control.

Table 6-2: Load combinations index

Load modes	Normal area (in terms of snowfall)	Area with heavy snowfalls
Normal	G+P+F+T	G+P+F+S+T
Earthquake	G+P+F+K+T	G+P+F+K+S+T
Strong wind	G+P+W+T	G+P+W+S+T
	G+P+F+W+T	G+P+F+W+S+T
Snowfall	G+P+F+S+T	G+P+F+S+T

Where:

G: dead load of the pond and its accessories

P: live load

- F: water pressure
- K: seismic load
- S: snow load
- T: load due to temperature
- W: wind load

6-1-8-Seismic calculations of on-ground tanks

In the Housner method, the effect of hydrodynamic pressure during earthquake is divided into two categories: impulsive forces (forces caused by rigid movements of water); turbulence forces (forces caused by water turbulence).

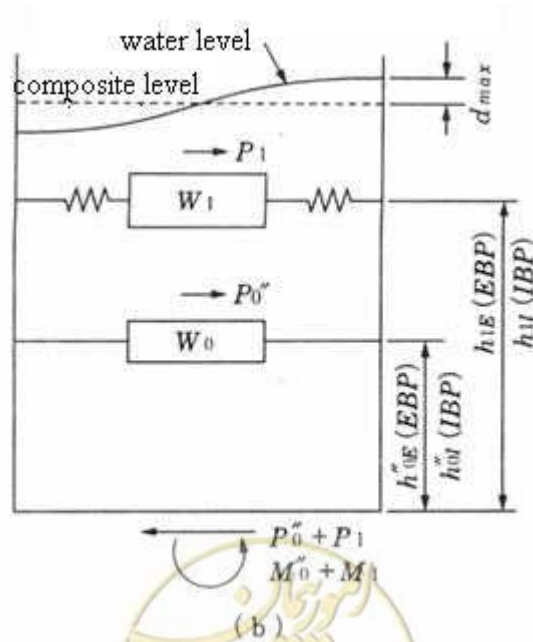
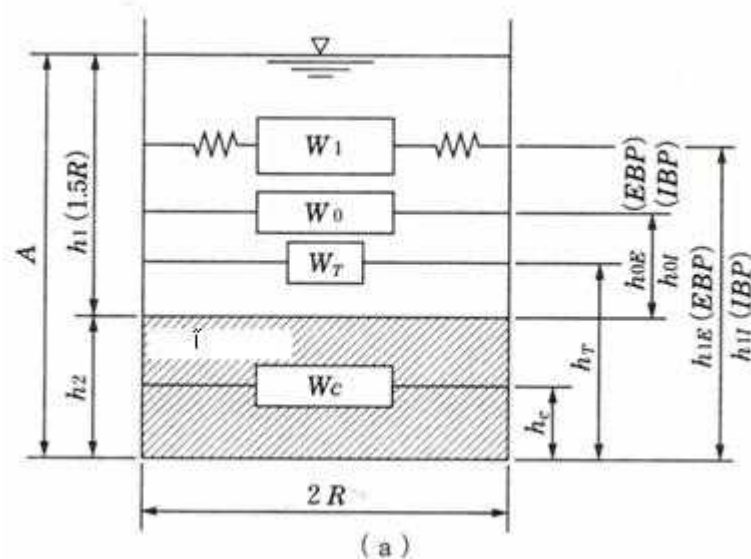

Figure 6-2: Dynamic model for water tank (when $h < 1.5R$)

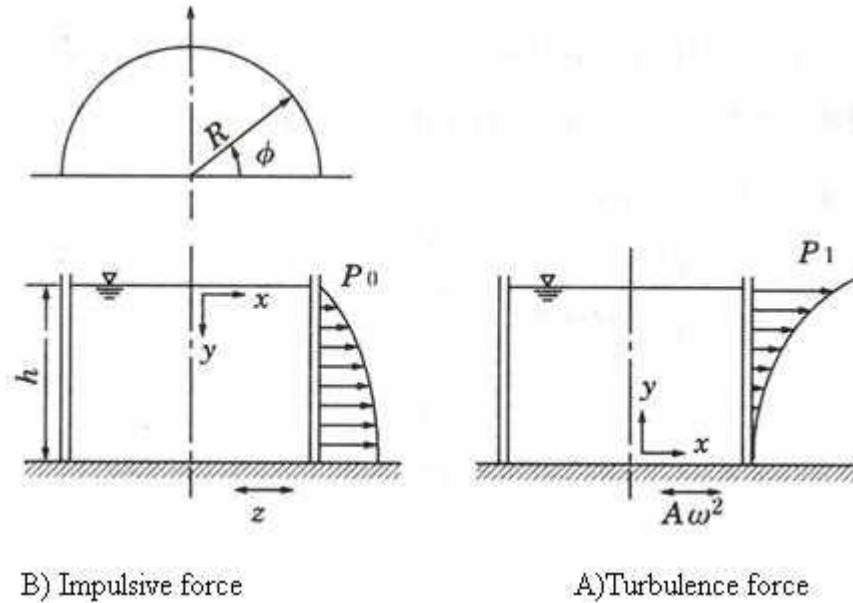

Figure 6-3: Housner water pressure model

- Impulsive force (for cylindrical water storage tanks)

$$P_0 \left\{ \begin{aligned} &= \rho \cdot \ddot{z} \cdot h \cdot \sqrt{3} \left\{ \left(\frac{y}{z} \right) - \frac{1}{2} \left(\frac{y}{z} \right)^2 \right\} \tanh \left(\sqrt{3} \frac{R \cdot \cos \varphi}{h} \right) \quad (h \leq 1.5R) \\ &= \rho \cdot R \cdot \ddot{z} \cos \varphi \quad (h \leq 1.5R) \end{aligned} \right. \quad (6-9)$$

- Turbulence force (for cylindrical water storage tanks)

$$P_1 = \rho \cdot A \cdot \omega^2 \cdot R \cdot \frac{15}{16} \left(1 - \frac{\cos^2 \varphi}{3} - \frac{\sin^2 \varphi}{2} \right) \cos \varphi \frac{\cosh \left(\sqrt{\frac{27}{8}} \cdot \frac{y}{R} \right)}{\cosh \left(\sqrt{\frac{27}{8}} \cdot \frac{h}{R} \right)} \quad (6-10)$$

The Housner seismic calculation method relations for plump pipes are shown in Table 6-3. These relations are used when the tank height (h) is less than 1.5 R. When the tank height is more than 1.5, calculations are done assuming that water level is higher than the water level that is fixed on the tank floor. This model is based on a simple assumption; hence in using this model examination of the stress and deformation in the deformed area of the side walls of the tank is hard. Moreover, this model is not suitable for calculations of elevated water tanks and tanks with thin walls. In designing structures of high-importance it is recommended to use the finite element method to ensure more safety.



Table 6-3: Housner seismic calculations method for tanks (R h<150)

Cylindrical water tank	Rectangular water tank
$\frac{W_0}{W} = \frac{\tanh\left(\sqrt{3}\frac{l}{h}\right)}{\sqrt{3}\frac{l}{h}}$	$\frac{W_0}{W} = \frac{\tanh\left(\sqrt{3}\frac{R}{h}\right)}{\sqrt{3}\frac{R}{h}}$
$h_0 = \frac{3}{8}h \quad (\text{EBP})$	$h_0 = \frac{3}{8}h \quad (\text{EBP})$
$\frac{h_0}{h} = \frac{1}{8}\left(\frac{4W}{W_0} - 1\right) \quad (\text{IBP})$	$\frac{h_0}{h} = \frac{1}{8}\left(\frac{4W}{W_0} - 1\right) \quad (\text{IBP})$
Impulsive force	Impulsive force
$P_0 = \frac{u_0 W_0}{g}$	$P_0 = \frac{u_0 W_0}{g}$
$\frac{W_1}{W} = 0.527 \frac{l}{h} \tanh\left(1.58 \frac{h}{l}\right)$	$\frac{W_1}{W} = 0.318 \frac{R}{h} \tanh\left(1.84 \frac{h}{R}\right)$
$\frac{h_1}{h} = 1 - \frac{\cosh\left(1.58 \frac{h}{l}\right) - 1}{1.58 \frac{h}{l} \sinh\left(1.58 \frac{h}{l}\right)} \quad (\text{EBP})$	$\frac{h_1}{h} = 1 - \frac{\cosh\left(1.84 \frac{h}{R}\right) - 1}{1.84 \frac{h}{R} \sinh\left(1.84 \frac{h}{R}\right)} \quad (\text{EBP})$
$\frac{h_1}{h} = 1 - \frac{\cosh\left(1.58 \frac{h}{l}\right) - 2}{1.58 \frac{h}{l} \sinh\left(1.58 \frac{h}{l}\right)} \quad (\text{IBP})$	$\frac{h_1}{h} = 1 - \frac{\cosh\left(1.84 \frac{h}{R}\right) - 2.01}{1.84 \frac{h}{R} \sinh\left(1.84 \frac{h}{R}\right)} \quad (\text{IBP})$
$\omega^2 = \frac{1.58g}{l} \tanh\left(1.58 \frac{h}{l}\right)$	$\omega^2 = \frac{1.84g}{R} \tanh\left(1.84 \frac{h}{R}\right)$
$\theta_h = 1.58 \frac{A_1}{l} \tanh\left(1.58 \frac{h}{l}\right)$	$\theta_h = 1.534 \frac{A_1}{R} \tanh\left(1.84 \frac{h}{R}\right)$
Turbulence force	Turbulence force
$P_1 = W_1 \theta_h \sin \omega t$	$P_1 = 1.2 W_1 \theta_h \sin \omega t$
$d_{\max} = \frac{0.527 l \coth\left(1.58 \frac{h}{l}\right)}{\frac{g}{\omega^2 \theta_h l} - 1}$	$d_{\max} = \frac{0.408 R \coth\left(1.84 \frac{h}{R}\right)}{\frac{g}{\omega^2 \theta_h R} - 1}$

EBP: when water pressure on the tank floor is unimportant.

IBP: when water pressure on the tank floor is taken into account.

The steps of seismic calculations of cylindrical water tanks introduced in Table 6-3 are explained below regarding Figure 6-2.

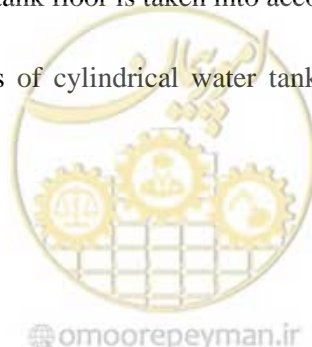

1- If $h/R > 1.5$, water of level higher than $1.5R$ is dependent on vibration and water of level below this level moves along the tank where it is still.

2- Calculations of impulsive force, P_0 .

$$R/h_1 = \frac{1}{1.5} \quad (6-11)$$

$$W = \rho \cdot \pi \cdot R^2 \cdot h_1 \quad (6-12)$$

Where:

ρ : unit weight of water (N/m^3)

By putting the value above in relation 6-13, the equivalent weight of water that results in the impulsive force, P_0 , is obtained.

$$W_0 = \frac{\tanh\left(\sqrt{3} \frac{R}{h_1}\right)}{\sqrt{3} \frac{R}{h_1}} W \quad (6-13)$$

In which the operating weight, W_0 , is as follows:

$$h_{0E} = \frac{3}{8} h_1 \quad (6-14)$$

(Pressure regardless of the floor pressure is briefly referred to as EBP)

$$h_{0E} = \frac{1}{8} \left[\frac{4}{\tanh\left(\sqrt{3} \frac{R}{h_1}\right) - 1} \right] \frac{\sqrt{3} \frac{R}{h_1}}{\sqrt{3} \frac{R}{h_1}} \quad (6-15)$$

(Pressure regarding the floor pressure is referred to as IBP from now on)

Weight of water that is still at a depth of $1.5R$ or more is calculated using relation 6-16.

$$W_c = \rho \pi R^2 h_2 \text{ (KN)} \quad (6-16)$$

Operating height of load is:

$$h_c = \frac{h_2}{2} \text{ (m)} \quad (6-17)$$

The secondary weight of the bearing structure is expressed as (W_T) and the location of gravity center is expressed as h_T .

The equivalent weight of water (W_0'') required for induction of impulsive force in tank walls (P_0'') is calculated by relation 6-18.

$$W_0'' = W_0 + W_c + W_T \text{ (kN)} \quad (6-18)$$

The operating height of this force is calculated using relation 6-20.

$$h_{0E}'' = \frac{W_0(h_{0E} + h_2) + W_c \cdot h_c + W_T \cdot h_T}{W_0''} \text{ (m) EBP} \quad (6-19)$$

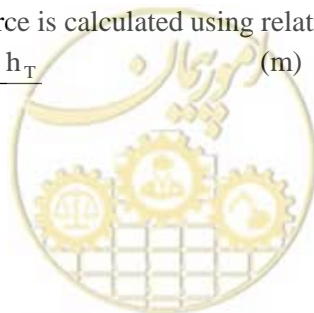

$$h_{0I}'' = \frac{W_0(h_{01} + h_2) + W_c \cdot h_c + W_T \cdot h_T}{W_0''} \text{ (m)} \quad \text{IBP} \quad (6-20)$$

The equivalent width, $T=0$, in the acceleration response spectrum is expressed as acceleration (\dot{u}_0) acting on weight (W_0''). Then the resulting impulsive force is calculated as below:

$$P_0'' = \frac{\dot{u}_0}{g} W_0'' \text{ (kN)} \quad (6-21)$$

And the bending moment due to P_0'' on exactly above the floor is calculated using relations 6-23 and 6-24.

$$M_{0E}'' = P_0'' \cdot h_{0E}'' \text{ (kNm)} \quad \text{(EBP)} \quad (6-22)$$

$$M_{0I}'' = P_0'' \cdot h_{0I}'' \text{ (kNm)} \quad \text{(IBP)} \quad (6-23)$$

3-Calculations of turbulence force, P_1

The equivalent vibration weight of water, W_1 , which causes the turbulence force P_1 , can be calculated by putting R/h and the weight of water contained in the tank (W) into relation 6-25.

$$W_1 = 0.318 \frac{R}{h} \tanh\left(1.84 \frac{h}{R}\right) \cdot W \text{ (kN)} \quad (6-24)$$

Operating height of load, h_1 , is obtained from relations 6-26 and 6-27.

$$h_{1E} = \left\{ 1 - \frac{\cosh\left(1.84 \frac{h}{R}\right) - 1}{\left(1.84 \frac{h}{R}\right) \sinh\left(1.84 \frac{h}{R}\right)} \right\} \cdot h \text{ (m)} \quad \text{EBP} \quad (6-25)$$

$$h_{1I} = \left\{ 1 - \frac{\cosh\left(1.84 \frac{h}{R}\right) - 2.01}{\left(1.84 \frac{h}{R}\right) \sinh\left(1.84 \frac{h}{R}\right)} \right\} \cdot h \text{ (m)} \quad \text{EBP} \quad (6-26)$$

Natural frequency of water surface, ω , is calculated by relation 6-28.

$$\omega^2 = \frac{1.84g}{R} \tanh\left(1.84 \frac{h}{R}\right) \quad (6-27)$$

Natural period can also be obtained based on the value of ω .

$$T = \frac{2\pi}{\omega} \text{ (s)} \quad (6-28)$$

The maximum range of W_1 , which is expressed as A_1 , can be calculated knowing the amounts of S (which is obtained from the velocity response spectrum based on damping value and the corresponding period T) and the vibrating mass:

$$A_1 = S / \omega \text{ (m)}$$

The angle of free vibration of water level (θ_h):

$$\theta_h = 1.534 \frac{A_1}{R} \tanh\left(1.84 \frac{h}{R}\right) \text{ (rad)} \quad (6-29)$$

In this case the vibration force, P_1 , is equal to:

$$P_1 = 1.2W_1 \cdot \theta_h \cdot \sin \omega t \quad (6-30)$$

Therefore:



$$P_1 = 1.2W_1 \cdot \theta_h \quad (6-31)$$

The bending moment caused by turbulence forces is calculated as:

$$M_{IE} = P_{1\max} h_{IE} \quad (\text{EBP}) \quad (6-32)$$

$$M_{II} = P_{1\max} h_{II} \quad (\text{IBP}) \quad (6-33)$$

Moreover, the maximum displacement of water surface is obtained from relation 6-34.

$$d_{\max} = \frac{0.408R \coth\left(1.84 \frac{h}{R}\right)}{\frac{g}{\omega^2 \theta_h R} - 1} \quad (6-34)$$

4-According to obtained results, the maximum operating bending moment in the horizontal section of the tank (exactly above the tank floor) is calculated using relation 6-35.

$$M_E = M_{0E}'' + M_{IE} \quad (\text{EBP}) \quad (6-35)$$

The maximum overturning moment in the horizontal plane (exactly beneath the water tank floor) is obtained as follows:

$$M_I = M_{0I}'' + M_{II} \quad (\text{IBP}) \quad (6-36)$$

P_{\max} is obtained using relation 6-38:

$$P_{\max} = P_0'' + P_1 \quad (6-37)$$

Where:

A_1 : maximum displacement of W_1 in terms of meter ($A_1 = S/\omega$).

d_{\max} : liquid surface maximum displacement.

EBP: when water pressure in the tank floor is unimportant.

F: sum of seismic loads (kN) that is equal to ($F = F_0 + F_1$).

F_0, F_1 : seismic loads put on W_0, W_1 in terms of (kN).

g: gravity acceleration in terms of (m/s^2).

h: height of liquid level from water tank in terms of (m).

h_0, h_0, h_1 : vertical distance of the equivalent load from water tank $W_0, W_0^{||}, W_1$ in terms of meters.

IBP: when water pressure in the tank floor is unimportant.

k: spring constant (kN/m^2).

k_1 : spring constant for equivalent weight, W_1 , in terms of (kN/m^2).

k_0 : spring constant for equivalent weight, W_0 , in terms of (kN/m^2).

I: half the length of rectangular tank in terms of meters.

m: vibrating mass (kN).

M_0, M_1 : bending moment due to P_0, P_1 that is applied to the horizontal section of water tank above the tank floor (kN.m).

M_0 : modified value of M_0 corresponding to the equal weight, $W_0^{||}$ (kN.m).

P_1, P_0 : impulsive force and vibration force (kN).

P_0 : modified P_0 that corresponds to the equal weight, $W_0^{||}$ (kN).

R: cylindrical tank radius (m)

S: velocity response spectrum

T: vibration period in terms of seconds

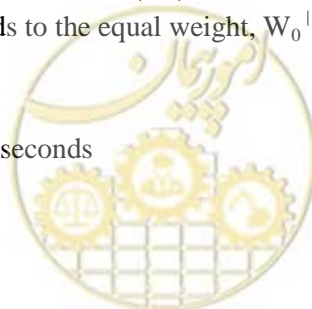

u_0 : maximum earth acceleration during earthquake

W : Total weight of fluid contained in a cylindrical tank. Fluid weight in finite width of a rectangular vessel (calculated width that is perpendicular to the length) (kN).

W_0 : equivalent weight of the fluid that induces the impulsive force (P_0), which is exerted on tank walls. (it is assumed that W_0 is fully tied to the tank walls at the height of h_0 from its floor) (kN).

W_0 : equivalent gross weight that induces the impulsive force, P_0 , which acts on tank walls. (W_0 , is the sum of tank weight and the weight of bearing structure).

If a tank with thin walls has a height of $h > 1/5L$ or $h > 1/5R$, W_0 will include the weight of bound water as well. (Forces, arms and members are referred to as with P_0 , h_0 , M_0 respectively) (kN).

W_1 : equivalent vibrating weight that induces the turbulence force, P_1 , which acts on tank walls. (It is assumed that W_1 is tied to tank walls with springs at heights of h_1 from the tank floor) (kN).

Θ_h : angular vibration of fluid surface.

p : mass density of fluid.

ω : circular frequency of free vibration of vibrating movement of fluid surface (rad/s).

6-1-9-Structural considerations

The tank structure must be constructed of reinforced concrete, prestressed concrete and steel. It must also be waterproofed and adequately safe.

Description:

In addition to inertia force, hydrodynamic force is also exerted on a tank during earthquake. Therefore, using aggregates with high levels of strength and adequately safe and waterproofed is necessary. The structure should also be constructed of reinforced concrete, prestressed concrete, or steel. The shape of the [resulting] structure is often cylindrical which makes it suitable for hydrodynamic pressure and wind pressure.

Design of this type of tank can be carried out according to issue 123, Iranian concrete regulations, the ninth topic of Iranian national building code or any other valid regulations.

1-Reinforced concrete tank

It is better to construct a rectangular or cylindrical reinforced concrete tank with side walls, a floor and a dome roof.

Tensile stress due to hydrodynamic pressure is always induced in the peripheral direction of the water tank structure and during earthquake larger tensile stresses are caused due to cyclic loads, inertia force and hydrodynamic pressure.

The arrangement of main bars and shear bars shall be designed and implemented properly according to the standards of concrete structures.

To avoid the penetration of water and chlorine, either the reinforced concrete should be equipped with adequate coating or epoxy resin colors should be used to color the inside of the water tank.

2-Prestressed concrete

Prestressed concrete tanks are usually cylindrical tanks with circular domes and roofs or prefabricated plates.



Concrete stands are distributed along the perimeter of the tank parallel to peripheral tensile stresses that are caused by hydraulic pressure of its containing liquid.

Vertical stands lead to compression of concrete in this direction and prestressed concrete does also show resistance to bending moments.

In the construction phase, standards of concrete structures shall be taken into consideration. Distances between PC cables and bars in prestressed concrete should be controlled. Seismic calculations need combination of loads. Moreover, examination of the state of concrete before and after prestressing is also necessary.

The junction between the side walls and the floor can be a fixed, hinged, or idle junction. In boundary conditions, the design stress greatly differs from the actual stress. Therefore, proper examinations should be done.

After putting stress on PC bars, injection into the coating should be quickly done.

3-Steel tank

A steel tank is generally a cylinder with a flat floor and a dome roof that is constructed through welding.

Foundation of the steel tank should be a spread or a pile foundation. Moreover, enhancement of the ground beneath the foundation should prevent irregular settlements. The lower part of the side walls should also be particularly constructed on a concrete foundation.

Between the foundation and the floor plate an infrastructure layer (subfloor) with asphalt mortar shall be placed in order to prevent corrosion of the subfloor.

Quality control should be done using the non-destructive examination method.

Steel tanks are preferred in terms of aggregates strength and quality of waterproofing, but they are involved with corrosion problems. Hence, using epoxy resin colors in the interior wall of these tanks and also weather-resistant colors in their exterior walls is necessary.

6-2-Aerial tanks¹

6-2-1-Seismic calculations method

1-Seismic calculations of aerial tanks should be carried out using a calculation method which employs a suitable model based on the type, importance and location of the structure and its surrounding environment.

2-Generally if risk level 1 is used, seismic calculations for elastic analysis are done using the quasi-static method.

3-If risk level 2 is used; seismic calculations should be performed using the plastic analysis method. For large-scale, complex structures of high importance the dynamic analysis method should be used to evaluate safety with regard to the characteristics of the structure. In modeling the structure, non-linear conditions shall be considered as well.

Description:

Natural period of aerial tanks is larger compared to other structures. Therefore, for tanks with high and very high levels of importance the dynamic analysis method shall be employed.

¹ Elevated tanks



Using the response spectrum method the ultimate response can be easily obtained. In operating conditions, two masses are modeled: free water; and the combination of the structure and still water (Figure 6-4). Free water has the particular natural period of its own.

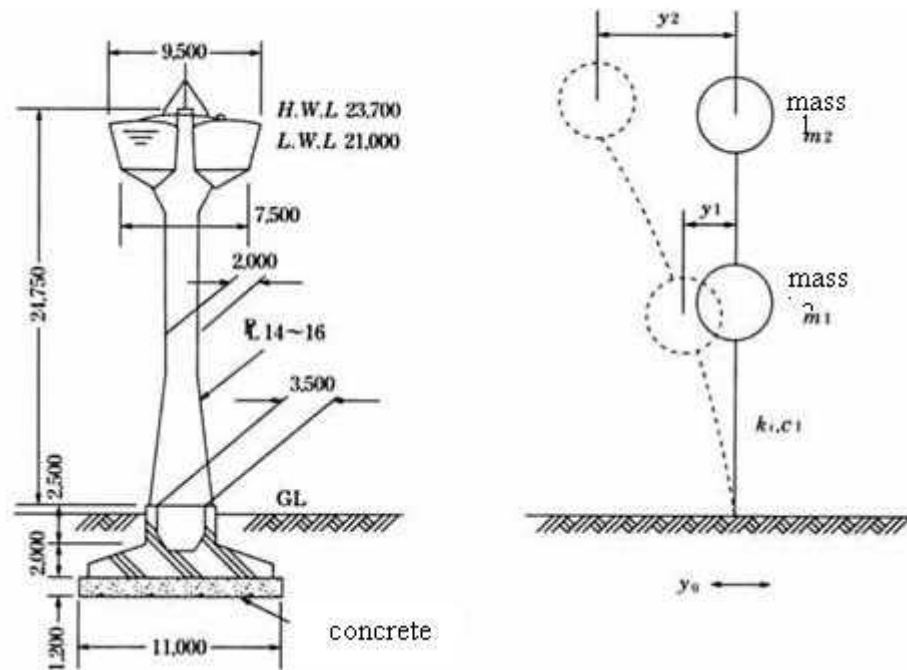

Figure 6-4: Sample dynamic analysis model for aerial tanks

6-2-2-Effects of earthquake

Effects of earthquake on aerial tanks are mainly similar to those of on-ground tanks.

6-2-3-Seismic input

Seismic inputs to aerial tanks should follow those mentioned for on-ground tanks.

Description:

Seismic force exerted on aerial tanks can be calculated by analyzing the whole structure as a vibrating system and by considering their dynamic characteristics. Vibrating and dynamic effects of the liquids contained in the tanks should also be taken into consideration in calculations.

1-Several design methods are available in which dynamic characteristics of structures are considered as well. The dynamic analysis method is one of these methods that is implemented as follows:

1-1-By assuming the proper static seismic coefficient for structural calculations the area of aggregates is determined.

By measuring the section rigidity, ultimate strength, and the special period of the structure can be determined.

1-2-Through dynamic analysis the external force, relative deformation, and shearing force coefficient (as a response to the external force) are calculated.

1-3-If needed, the supposed earthquake force and sectional force should be modified. Details should also be modified based on new calculations.

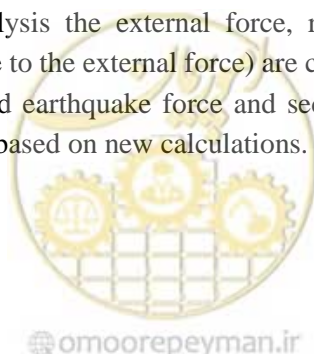

Safety control should be carried out to examine flexibility of each part to deformation.

2-Aerial tanks are composed of water, a bearing structure and a tank. Water inside the tank is less structure-dependent and has open surface of its own corresponding to its characteristics. Water in the tank has its own period due to the gravity acceleration and its open surface. Vibration of aerial water tanks is section-specific in the structure. The following methods are available for vibration of aerial tanks.

2-1-A method in which water movements due to hydrodynamic behavior and total vibration of the aerial tank are taken into consideration, assuming the manner of interaction between water and the structure.

2-2-A method in which water is transformed into a vibrating system with enough mass and rigidity.

Due to the difficulties associated with implementation of method 1-1, method 2-2 (simulation of a vibrating system) is preferred. Practical and theoretical mechanisms of method 1-2 are explained below.

3- Tank water turbulence

Several types of water movement and tank shapes do exist. As it can be seen in Figure 6-5, when water depth, H, is adequately high in relation to water tank diameter, D, special period of tank water in the horizontal direction (based on one single degree of vibration), T_w , is calculated using relations 6-38 to 6-41.

$$(D: \text{cm}) (s) T_w = 0.11\sqrt{D}$$

rectangular tank (6-38)

$$(s) T_w = 0.10\sqrt{D}$$

cylindrical water tank with flat floor (6-39)

$$(s) T_w = 0.10\sqrt{D}$$

globe-shaped cylindrical water tank (6-40)

$$T_w = 0.11\sqrt{D}$$

cone-shaped water tank (6-41)



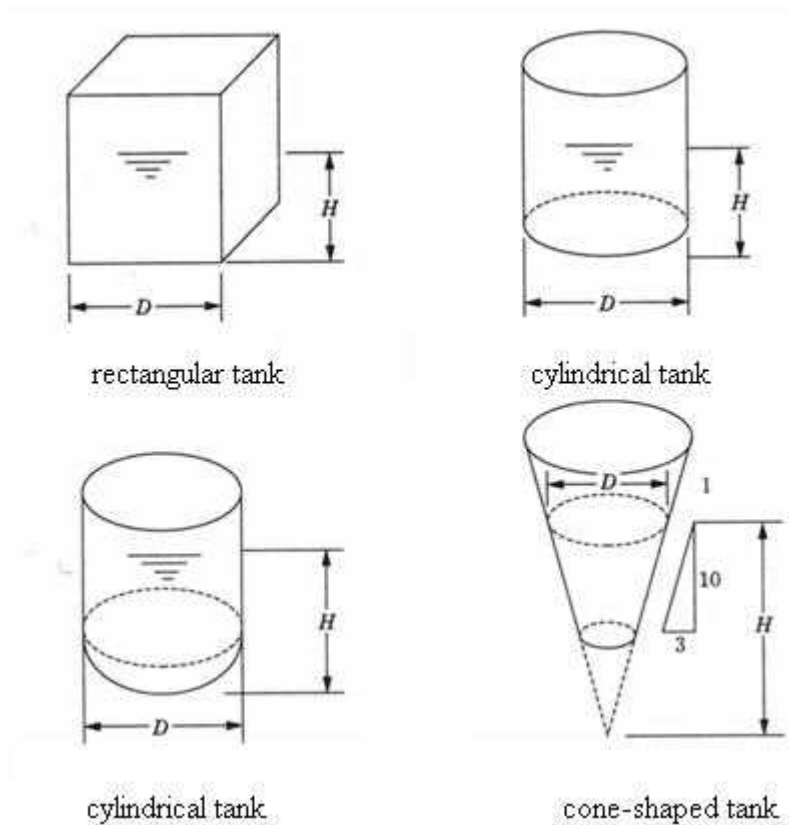

Figure 6-5: Shapes of water tanks

If the wavelength of vibrating water is twice the tank radius, then: $T_s \cong \frac{T_w}{2S-1}$

When water depth is low (as it is seen in Figure 6-6) the special period of water is more than what is obtained by relations above (based on one single vibration). When the value of vibration degree is shown by S , the high-degree vibration period is calculated using relation 6-43.

$$T_s \cong \frac{T_w}{2S-1} \quad (6-42)$$



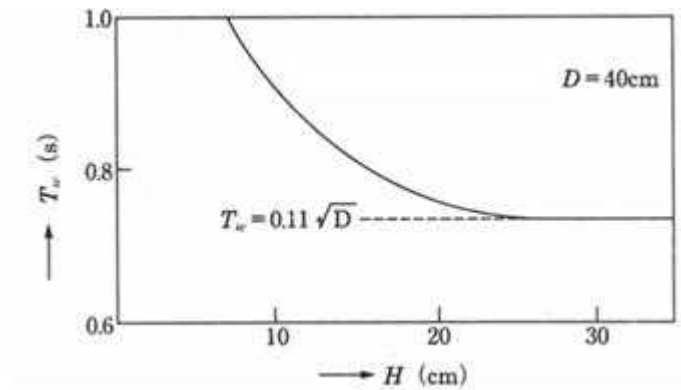

Figure 6-6: Water vibration sample test

Special period of water inside the tank is only affected by the tank radius (when water depth is high enough). Hence, water can be divided into two parts: free water that is dependent on its vibration; and still water that moves along the tank. When the amount of still water is high, natural period can be obtained using relation 6-43. Hence, aerial water tanks can be considered as transformed vibrating systems composed of free water and a structure (Figure 6-7). In this section structures with a high level of vibration are examined. If the weight of water tank and its bearing structure are altogether shown by W_0 , the special period for a waterless tank is shown by T_{F0} and the special period for a tank with water is shown by T_F , while relation 6-44 will also be true.

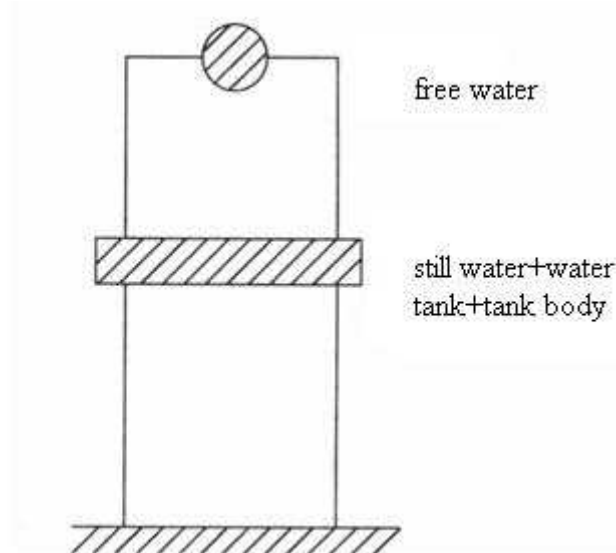

Figure 6-7 Alternative vibrating system

$$W_D = \left(\frac{T_F^2}{T_{F0}^2} - 1 \right) W_0$$

(6-43)



Special period is obtained from testing (T_F is calculated based on free and forced vibrations).

Depth of free water is obtained from relations 6-45 and 6-46.

$$H_F = 0.3D \text{ cylindrical} \quad (6-44)$$

$$H_F = 0.1H \text{ cone-shaped} \quad (6-45)$$

Where:

H_F : depth of free water (cm)

H : total water depth (cm)

D : radius of water tank surface (cm)

It should be noted that relation above is employed when water depth is somewhat higher than the radius of water tank surface. The results of the test carried out for a rectangular tank are shown in Figure 6-8.

Vibrating period of the upper section of a normal water tank is less than the vibrating period of water inside it. In such a case when the tank is vibrated, only part of its water, for example the still water that was mentioned earlier, acts as the effective mass. In seismic design of tanks still water can be used in calculating earthquake force as the effective loading weight.

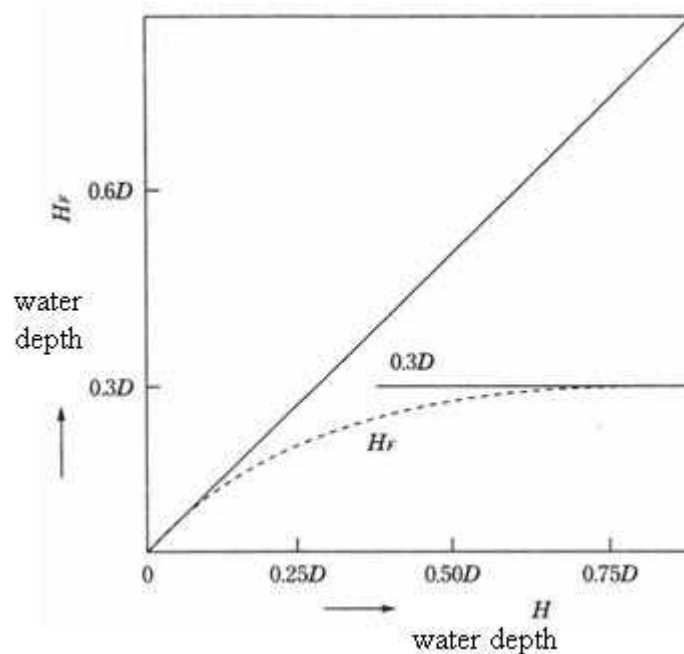

Figure 6-8: Free water inside a rectangular water tank

In designing large water tanks, the lateral pressure due to the movement of still water (impulsive pressure) and the lateral pressure exerted by free water on the walls should be taken into consideration.

6-2-4-Load combinations

Combination of loads in aerial tanks should follow combination loads for on-ground tanks.

Description:



When seismic and wind loads are taken into account, bearing structure sectional area differs based on the direction of loading. Hence, loading direction should also be controlled.

6-2-5-Seismic calculations of aerial water tanks

Natural period of aerial water tanks (the sample bearing structure of which is depicted in Figure 6-9) should be calculated with regard to the rigidity of their bearing structures; the associated response spectra should also be selected based on their natural periods.

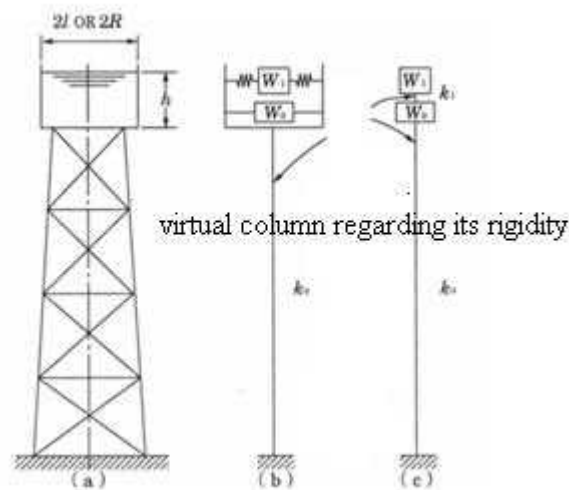

Figure 6-9: Aerial water tank

The associated equivalent weight, W_0 (to produce impulsive force), W_1 (to produce turbulence force), corresponding operating heights (h_1 , h_0) and the special circular frequency of fluid surface (ω) can be calculated independent of bearing conditions as is shown in Table 6-3.

The equivalent spring constant, k_1 , is obtained from the results of the above calculations using relations 6-46 to 6-48.

$$k_1 = \frac{\omega^2 W_1}{g} \quad (6-46)$$

$$m_a = \frac{W_0}{g}, m_b = \frac{W_1}{g} \quad (6-47)$$

$$k_{aa} = k_0 + k_1, k_{bb} = k_1, k_{ab} = k_{ba} = k_1 \quad (6-48)$$

Where:

k_0 : equivalent spring constant of the bearing structure

The two degrees of freedom circular frequency is obtained from relation 6-49.

$$\omega_n^2 = \frac{1}{2} \left\{ \frac{k_{aa}}{m_a} + \frac{k_{bb}}{m_b} + \sqrt{\left(\frac{k_{aa}}{m_a} - \frac{k_{bb}}{m_b} \right)^2 + 4 \frac{k_{ab}}{m_a} + \frac{k_{ba}}{m_b}} \right\} \quad (6-49)$$

Natural period is also calculated using the relation below:

$$T_n = \frac{2\pi}{\omega_n} \quad (6-50)$$



Natural models include:

$$\varphi_{an} = \frac{-(k_{ab} / m_a)}{(k_{aa} / m_a) - \omega_n^2} = \frac{-(k_{bb} / m_b) + \omega_n^2}{(k_{ba} / m_a)} \quad (6-51)$$

$$\varphi_{bn} = 1 \quad (n=1,2) \quad (6-52)$$

The peak seismic response to each mode is in the below order:

$$y_{an} = \beta_n \cdot \varphi_{an} \cdot \frac{S_n}{\omega_n} \quad (6-53)$$

$$y_{bn} = \beta_n \cdot \frac{S_n}{\omega_n} \quad (6-54)$$

β_n is the participation factor that can be calculated using relation 6-55.

$$\beta_n = \frac{\sum_{i=a,b} m_i \phi_{in}}{\sum_{i=a,b} m_i \phi_{in}^2} \quad (6-55)$$

S_n is the velocity response spectrum for mode n . the earthquake force and base seismic shear are calculated through relations 6-57 and 6-58.

$$F_{an} = k_{ab} y_{bn} + k_{aa} y_{an} (= -m_a \ddot{y}_{an}) \quad (6-56)$$

$$F_{bn} = k_{bb} y_{bn} + k_{ba} y_{an} (= -m_b \ddot{y}_{bn}) \quad (6-57)$$

Turbulence-induced apparent displacement of liquid surface is as follows:

$$\theta_A = 1.534 \frac{A_{1n}}{R} \tanh\left(1.84 \frac{h}{R}\right) \quad (6-58)$$

Where:

$$A_{1n} = y_{bn} - y_{an} \quad (6-59)$$

6-2-6-Structural considerations

Aerial tank structures must be constructed of reinforced concrete, prestressed concrete, and steel. These structures should also be adequately safe and waterproofed.

Description:

Design of aerial tanks should be done similar to that of pipe towers with regard to their safety and waterproofing. Although aerial tanks are built by reinforced concrete, prestressed concrete and steel, steel tanks are preferred due to their smaller mass, the strength of their aggregates and their high deformability.

These tanks can be cylindrical, globular or oval in form. In structural calculations: when side walls are thick, as in reinforced concrete tanks, analysis should be carried out using the bending theory; and when the side walls are thin, as in steel tanks, the shell theory is used with regard to changes in empty and full modes of tanks.

In reinforced concrete tanks, strong tensile stress may be caused due to hydraulic pressure, temperature changes and seismic forces. These tanks should be also designed according to the standards of concrete structures. Arrangement of reinforced bars should be properly done while intended bars should also be used.

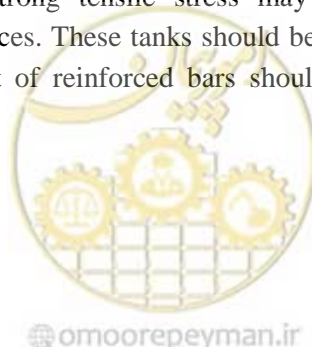

In prestressed concrete tanks, design should be carried out according to the standards of concrete structures. The limit state of concrete bending crack is defined as for a crack caused by bending moments and axial forces independent of tensile stress. Hydraulic pressure causes residual compressive stress while temperature stress and seismic stress somehow induce tensile stress. Tensile reinforced bars should be arranged properly.

In the steel tank shell theory, the stress of the section that undergoes deformation should be examined and also reinforcement should be carried out to increase the thickness of tank corners.

The bearing structure should be designed proportional to the tank. Also it should be constructed of concrete or steel in order to ensure the safety of the tank against the horizontal earthquake forces, wind loads and axial forces caused by head loads.

In seismic calculations, the axial force caused by head loads, bending stresses and shear stresses caused by earthquake and wind loads should be studied.

In frame and column structures, their torsional and buckling behavior should be controlled.

Reinforced concrete structures can be constructed as walled structures (cylindrical structures), rigid-framed structures, and multi-column structures. From the point of view of seismic analysis, walled and rigid-framed structures are safer than multi-column structures. In multi-column structures a cylindrical column is installed in the middle, which reduces horizontal earthquake forces.

Steel tanks are built as framed structures or multi-column structures. In order to prevent buckling, the junction of anchor bars should be boosted by gussets with adequate widths.

The tank and its bearing should not undergo slippage. This can be controlled using relation 6-61.

$$f_t^2 \geq \sigma_x^2 + \sigma_y^2 - \sigma_x \sigma_y + 3\tau_{xy}^2 \quad (6-60)$$

Where:

f_t : allowable tensile stress (Pa)

$\sigma_x \sigma_y$: vertical stresses along the transverse direction (Pa)

τ_{xy} : shear stress (Pa)

6-3-Allowable values

Components of the facilities of this section are mainly concrete or steel structures. The allowable values for these components are determined according to the design regulations criteria.

6-4-Response analysis of aerial and on-ground tanks

Generally, most on-ground and aerial tanks are classified as thin-walled cylindrical shell structures. Particularly, the seismic resistance of this type of tanks should be controlled by considering the water inside them. In seismic design of these tanks, the bodies are assumed to be thin-walled cylindrical shells; the stress and deformation of the tanks are calculated using the quasi-static method and the static response analysis method.

Here the finite element method with cylindrical thin shell elements is employed. This is a proper method for evaluation of the analyses of upper parts (walls and floors) of water tanks.

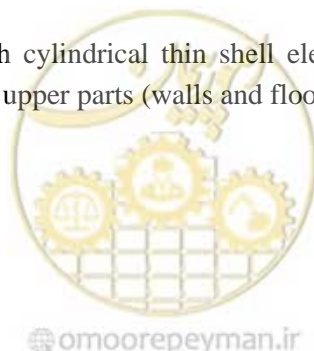

6-4-1-Application of the finite element method

It is assumed that shell structures with axial symmetry are divided into several cylindrical elements by two flat surfaces that are perpendicular to the axis.

When the load exerted on the shell is not symmetrical with the axial symmetry, in order to show the movement of the central point of the section three displacement components (u, v, w) and one angular displacement component (Θ) are required (Figure 6-11). The external force equal to this force, (V, T, H), and the bending moment is shown by (R). Junction line displacement and element displacement for the agent element, A, are determined using relations 6-62 to 6-64.

Joint line i

$$\{\bar{u}\}_i = [u_i, v_i, w_i, \beta_i]^T \quad (6-61)$$

Joint line j

$$\{\bar{u}\}_j = [u_j, v_j, w_j, \beta_j]^T \quad (6-62)$$

Element A

$$\{\bar{u}\}_A = \{\{\bar{u}\}_i, \{\bar{u}\}_j\}^T = [u_A, v_A, w_A, \beta_A]^T \quad (6-63)$$

Where:

w_A : displacement in the radial direction

u_A : displacement in the axis direction

v_A : displacement in the peripheral direction

β_A : angular displacement

The external forces for joint lines and the external force for the element corresponding to these displacements are obtained from relations 6-64 to 6-66.

Joint line i

$$\{\bar{f}\}_i = [V_i, T_i, H_i, R_i]^T \quad (6-64)$$

Joint line j

$$\{\bar{f}\}_j = [V_j, T_j, H_j, R_j]^T \quad (6-65)$$

Element A

$$\{\bar{f}\}_A = \{\{\bar{f}\}_i, \{\bar{f}\}_j\}^T = [V_A, T_A, H_A, R_A]^T \quad (6-66)$$

Where:

V_A : force along the z axis

T_A : force along the perimeter

H_A : force along the radial direction

R_A : bending moment



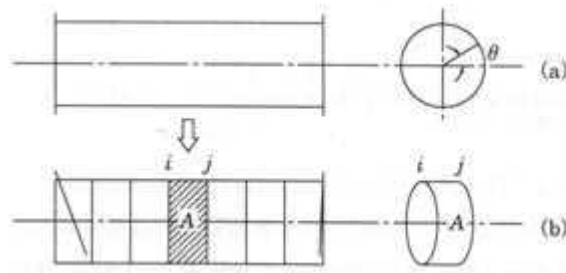

Figure 6-10 Structure model

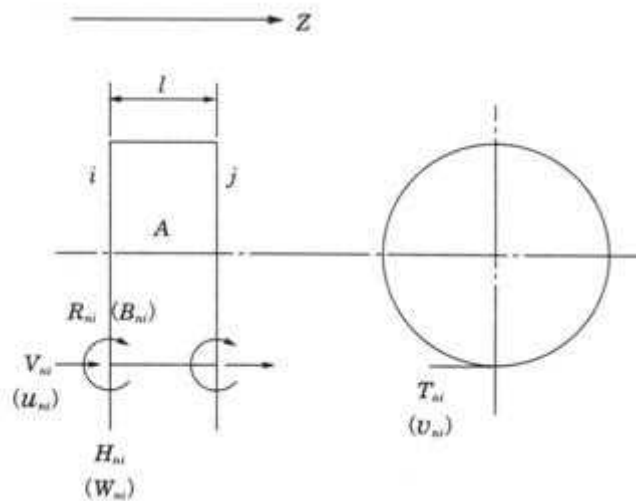
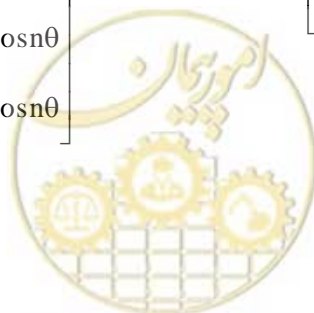

Figure 6-11: Element displacement and external force components

The displacements and external forces defined above can be calculated using relations 6-67 and 6-68.

$$\begin{aligned}
 \{\bar{u}(z, \theta)\}_A &= \begin{bmatrix} u_A(z, \theta) \\ v_A(z, \theta) \\ w_A(z, \theta) \\ \beta_A(z, \theta) \end{bmatrix} = \begin{bmatrix} \sum_{n=0}^m u_{nA}(z) \cos n\theta \\ \sum_{n=0}^m v_{nA}(z) \sin n\theta \\ \sum_{n=0}^m w_{nA}(z) \cos n\theta \\ \sum_{n=0}^m \beta_{nA}(z) \cos n\theta \end{bmatrix} = \sum_{n=0}^m \begin{bmatrix} \cos n\theta & 0 & 0 & 0 \\ 0 & \sin n\theta & 0 & 0 \\ 0 & 0 & \cos n\theta & 0 \\ 0 & 0 & 0 & \cos n\theta \end{bmatrix} \begin{bmatrix} u_{nA}(z) \\ v_{nA}(z) \\ w_{nA}(z) \\ \beta_{nA}(z) \end{bmatrix} \\
 &= \sum J_n \{\bar{u}_n(z)\}_A \quad (6-67)
 \end{aligned}$$

$$\begin{aligned}
 \{\bar{f}(z, \theta)\}_A &= \begin{bmatrix} V_A(z, \theta) \\ T_A(z, \theta) \\ H_A(z, \theta) \\ R_A(z, \theta) \end{bmatrix} = \begin{bmatrix} \sum_{n=0}^m V_{nA}(z) \cos n\theta \\ \sum_{n=0}^m T_{nA}(z) \sin n\theta \\ \sum_{n=0}^m H_{nA}(z) \cos n\theta \\ \sum_{n=0}^m R_{nA}(z) \cos n\theta \end{bmatrix} = \sum_{n=0}^m \begin{bmatrix} \cos n\theta & 0 & 0 & 0 \\ 0 & \sin n\theta & 0 & 0 \\ 0 & 0 & \cos n\theta & 0 \\ 0 & 0 & 0 & \cos n\theta \end{bmatrix} \begin{bmatrix} V_{nA}(z) \\ T_{nA}(z) \\ H_{nA}(z) \\ R_{nA}(z) \end{bmatrix}
 \end{aligned}$$



$$= \sum J_n \{\bar{f}_n(z)\}A \quad (6-68)$$

Where $\{\bar{u}_n(z)\}A$ and $\{\bar{f}_n(z)\}A$ show displacement and distribution along the z axis of the element external force.

The stresses obtained from the analyses include: stress along the axial direction (δ_z), stress along the peripheral line (δ_θ), and shear stress ($\tau_{z\theta}$) (Figure 6-12).

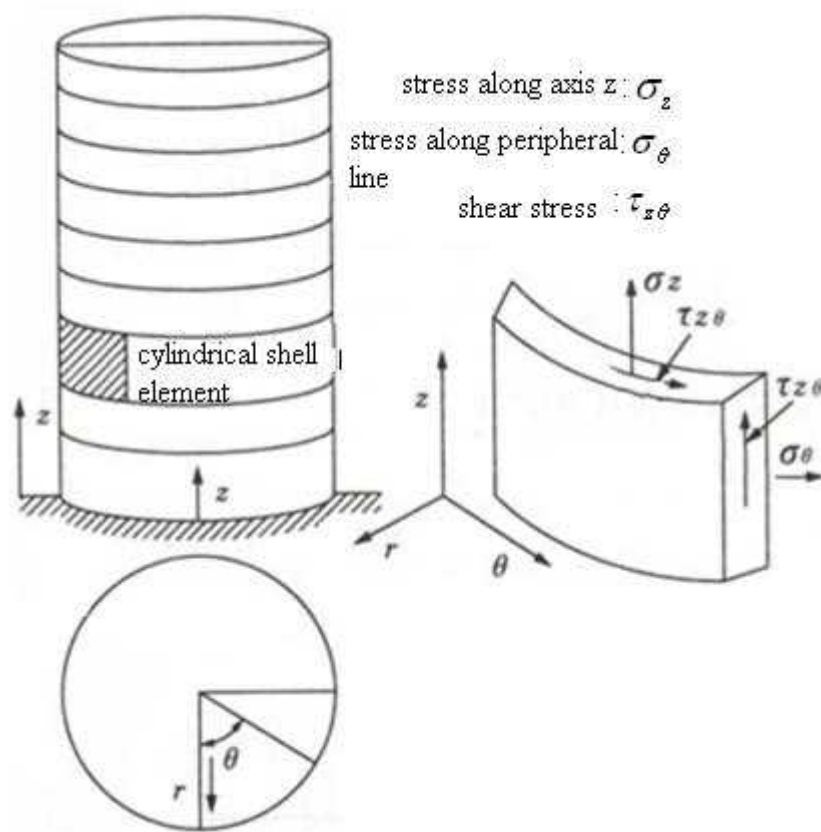

Figure 6-12: Cylindrical shell stress components

6-4-2-External forces conditions

The external forces exerted on the body of a cylindrical shell structure are included in Table 6-4.

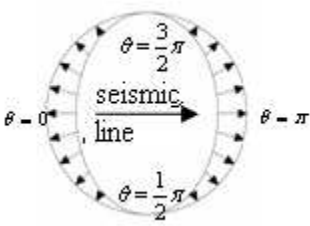
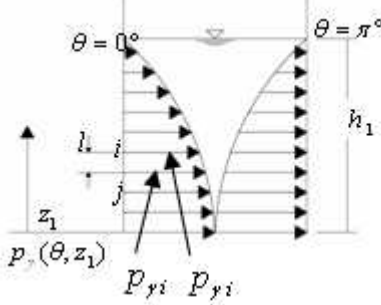
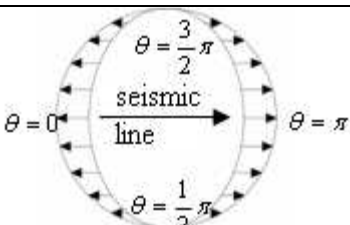
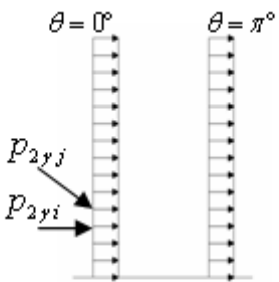

Table 6-4: (A) Distribution of load applied to aerial tanks

	Distribution along the peripheral line	Distribution along the depth
<p>1. Water dynamic pressure (p_{1r}) during earthquake</p>	 <p>Distribution along radial direction $p_{1r}(\theta, z_1) = \cos \theta$</p> <p>Distribution along the peripheral line $p_{1\theta}(\theta, z_1) = 0$</p>	 <p>$p_{yi} = K_h \gamma_0 a_i \cos \theta \times I\left(\frac{z_1}{h_1}\right) \quad kN/m^2$</p> <p>$I\left(\frac{z_1}{h_1}\right) = \sum_{i=0}^{\infty} \frac{(-1)^i}{\lambda_i} I^{(i)}\left(\frac{a}{h}\right) \cos\left(\lambda_i \frac{z_1}{h_1}\right)$</p>
<p>2. Inertia force (P_2) inside the tank during earthquake</p>	 <p>Distribution along radial direction $p_{2r}(\theta, z_1) = \cos \theta$</p> <p>Distribution along the peripheral line $p_{2\theta}(\theta, z_1) = \sin \theta$</p>	 <p>$p_{2yi}(\theta, z_1) = \gamma_c t K_h \cos \theta$</p> <p>$p_{2\theta}(\theta, z_1) = \gamma_c t K_h \sin \theta$</p> <p>Uniform distribution</p>



<p>3. Hydrostatic pressure (P_{sy})</p>	<p>Uniform distribution of pressure along the peripheral line</p> 	 <p>$P_{s_y}(\theta, z_1) = \gamma_0 (h_1 - z_1)$</p>
<p>4. Water tank self-weight</p>	 <p>Uniform load distribution along the peripheral direction</p>	

Table 6-4: Distribution of load applied to aerial tanks

	Earthquake tangential load
<p>1. Water dynamic pressure (P_{1r}) during earthquake</p>	<p>1- Load in the radial direction</p> $P_{\gamma_i} = \int p_{\gamma}(\theta, z_1)_{\gamma} d\theta dz_1 \cong \frac{1}{6}(2p_{\gamma_i} + p_{\gamma_i}) + \pi r l \quad (\text{kN})$ $P_{\gamma_i} \cong \frac{1}{6}(p_{\gamma_i} + 2p_{\gamma_i}) \quad (\text{kN})$
<p>2. Inertia force (P_2) inside the tank during earthquake</p>	<p>1- Force in the radial direction</p> $P_{2\gamma_i} = P_{2\gamma_j} = \gamma_c t K_h \times \pi r l \quad (\text{kN})$ <p>2- Force along the peripheral line</p> $P_{2\theta_i} = P_{2\theta_j} = \gamma_c t K_h \times \pi r l \quad (\text{kN})$
<p>3. Hydrostatic pressure (P_{sy})</p>	<p>1- Load in the radial direction</p> $P_S = \int p_S(\theta, z_1)_r d\theta dz_1 \cong \frac{1}{6}(2p_{S_i} + p_{S_i}) + \pi r l \quad (\text{kN})$ $P_{S_{ri}} = \int p_S(\theta, z_1)_r d\theta dz_1 \cong \frac{1}{6}(p_{S_i} + 2p_{S_i}) + \pi r l \quad (\text{kN})$

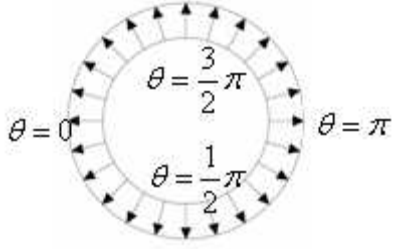
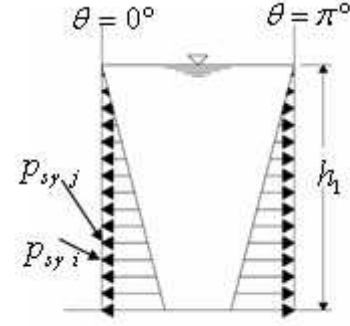
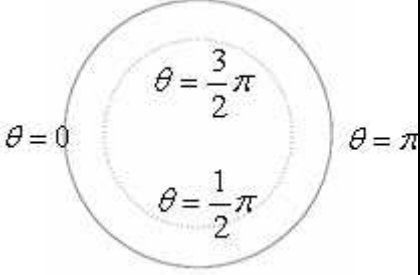
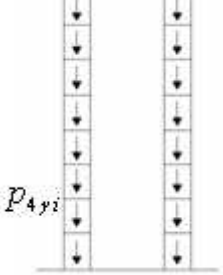
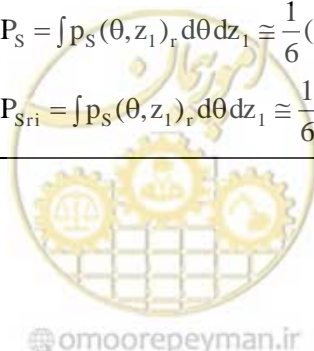

4. Water self-weight(P_{4x})	1- Load in the radial direction $P_{4zi} = P_{4zj} = p_{4zj} \times \pi r l = \gamma_c t \times \pi r l$ (kN)
----------------------------------	--

Note:

See the design formula 7-1.

t is the wall thickness and γ_c is the unit weight of water tank volume.

1-Hydrodynamic pressure of water storage tanks

In the tanks under discussion, the dominant load and water static pressure during earthquake and in normal conditions are equal to the hydrodynamic water pressure inside the tanks. Different types of hydrodynamic pressure are caused during earthquake. Pressures due to seismic horizontal vibrations and excess pressures caused by deformation of structures and ground. Pressures caused by seismic horizontal vibration are dominant over other hydrodynamic pressures caused during earthquake. The increase in the hydrodynamic pressure caused by deformation of water tanks is less than that of the last case. Hence, only water pressure due to horizontal vibration in water tanks is taken into account and the rest can be neglected. Evaluation of the hydrodynamic pressure of the water inside water tanks (P_{1r}) is described in section 3-12 similar to that of virtual mass distribution.

$$p_r(\theta, z_1) = K_{SH} \cdot \gamma_0 \cdot \cos\theta \cdot I\left(\frac{z_1}{h_1}\right) \text{ (kN/m}^2\text{)} \quad (6-69)$$

Where:

K_{SH} : seismic coefficient

γ_0 : water density (kN/m³)

z_1 : coordinate in relation to the tank floor in the upward direction

h_1 : water depth in the intake tower

Hydrodynamic pressure load is distributed through $\cos\theta$ in the perimeter and through $I\left(\frac{z_1}{h_1}\right)$ in the direction of water depth and radius.

2-Inertia force of water storage tanks during earthquake, p_2

$$p_2 = (p_{2r} + p_{2\theta}) \text{ (kN/m}^3\text{)} \quad (6-70)$$

Where:

$$p_{2r}(\theta, z_1) = \gamma_c t \sin\theta \cdot K_H \text{ (kN/m}^2\text{)} \quad (6-71)$$

$$p_{2\theta}(\theta, z_1) = \gamma_c t \cos\theta \cdot K_H \text{ (kN/m}^2\text{)}$$

$p_{2r}(\theta, z_1)$ is the load in the radial direction in terms of $\cos\theta$ distribution in the perimeter. This load is uniformly distributed along the tank depth.

$p_{2\theta}(\theta, z_1)$ is the peripheral load that is circularly distributed through $\sin\theta$ and is distributed uniformly in the depth direction.

3-Water static pressure, P_{sr}

This pressure is uniformly distributed along the peripheral line. This distribution is illustrated below.

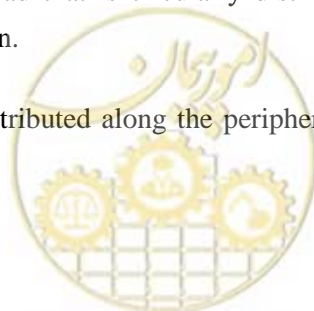

$$p_{sr}(\theta, z_1) = \gamma_0 (h_1 - z_1) \text{ (kN/m}^2\text{)} \quad (6-72)$$

This load is applied in the radial direction.

4-Weight of water tank walls, P_{sr}

Weight of a water tank is uniformly distributed along both the peripheral and depth lines.

$$p_{4z}(\theta, z_1) = \gamma_c \cdot t \text{ (kN/m}^2\text{)} \quad (6-73)$$

Where:

γ_c : density of water tank aggregates (kN/m³)

t : thickness of water tank walls (m)

$p_{4z}(\theta, z_1)$: unit weight of tank wall surface

This force acts downwards in the z axis.

6-4-3-Calculation conditions

1- Boundary conditions

The boundary conditions are associated with the condition of the junctions between the walls and the lower part of a tank.

If the fixed edge is to be placed on the ground, it must be fully fixed. And if it is fixed by hinged supports, then we will have: ($u = v = w = 0$) When the water tank is covered by a coating, either its rigidity should be increased or limiting conditions should be taken into consideration for it.

2- Load conditions

Load conditions (for each type mentioned in previous sections) are evaluated as the joint line equivalent load, P (kN). Calculations of joint line loads are carried out using Fourier integral operators and along the peripheral line. Load distribution is similar to linear load distribution along the axial direction. Then using the relations below the distributed load is transformed into equivalent concentrated load (P_i, P_j). This load is very similar to concentrated load along the depth line.

$$p_i = \frac{1}{6} \{2f(z_i) + f(z_j)\}l \text{ (kN/m)} \quad (6-74)$$

$$p_j = \frac{1}{6} \{2f(z_j) + f(z_i)\}l \text{ (kN/m)} \quad (6-75)$$

Using Fourier integral operators for P_i and P_j in the peripheral line, the joint line equivalent loads for P_j and P_i are obtained.

$$P_i = p_i \cdot \pi \cdot r = \frac{1}{6} \{2f(z_i) + 2f(z_j)\} \pi \cdot \gamma \cdot l \quad (6-76)$$

$$P_j = p_j \cdot \pi \cdot r = \frac{1}{6} \{f(z_i) + 2f(z_j)\} \pi \cdot \gamma \cdot l \quad (6-77)$$

Where:

$f(z_i) f(z_j)$: Intensity of the distributed loads
of external forces at points i and j (kN/m²).

l : element width



6-4-4-Element partitions

Water storage tanks are divided into thin cylindrical shell elements. At the lower parts of the tank where loading conditions are tougher, elements are divided into smaller conditions. These divisions are wider near the top, where the load is trivial. For instance, a water tank with the height of 20 meters and element width of between 50 to 100 centimeters is employed. To a height of about five meters from the tank floor, widths of 50 centimeters long can be used. Moving upwards toward the element top, width is increased for approximately 10 centimeters at first and is gradually increased to reach a length of 100 centimeters at the top of the water tank.



Chapter 7

Seismic Design and Safety Control of Water Supply Pipelines



7-1-Water supply pipelines

Pipelines form a large part of the water supply network. Pipelines in urban water supply networks are tens of thousands of kilometers long.

Much of the investment in the water supply systems is allocated to implementation of pipelines and their repair and maintenance. Almost most pipelines are buried and their repair requires drilling operations in the passageways.

The most important parts of the pipelines in a distribution network are their junctions, which are the most vulnerable part of the network to the effects of earthquake left on the system.

Recovery (water supply), reconstruction (repairing damages), repair (damage), and replacement (destroyed and ruined) of buried components (mainly the pipes) are extremely time consuming, labor-intensive and expensive.

Seismic design and safety control of buried pipelines against earthquake can have lots of advantages from the administrative (economic, social and operational) and engineering points of view.

Before addressing distribution networks transmission lines should be discussed. Although the length of these lines is much less than that of distribution lines, these are of greater importance due to their degree of effectiveness in water provision.

After the secondary distribution lines, tens of thousands of kilometers of customer service pipelines are also implemented, which are of smaller diameters compared to the distribution network lines and are less important as well. Hence, a considerable part of the damages to water supply systems target these pipes.

In this chapter of this guideline the important and useful tips for seismic design of urban water supply systems pipelines are included.

7-2-Target components

Transmission and distribution pipelines include the following structures:

- 1-Buried pipeline (unbroken and disjoint)
- 2-Shaft
- 3-Conduit
- 4-Common channel
- 5-Tunnel
- 6-On-ground lines or a pipe bridge (that passes bridges or bridge-like structures on bearings and in the air)

Goals of this chapter are classified as follows in other terms:

- 1-Buried pipelines
- 2-On-ground pipelines

Description:

1-Buried pipelines

Currently the majority of the conduits are buried into the ground for protection and proper transmission of load.

Conduits constructed on roads and streets are composed of straight sections, 45- and 90-degree flexures and convex and concave arches. To ensure proper functionality usually flexures with high angles are now allowed.

Different modes of buried pipes are illustrated in Figure 7-1.





	
A) Straight conduit	B) Subway
	
C) Concave arch	D) Convex arch

Figure 7-1: Modes of buried pipelines

2-On-ground pipelines

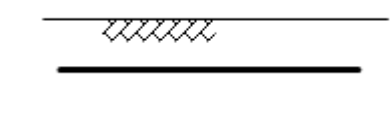
Although most pipelines are buried, burial of pipelines into some grounds is not possible and thus conduits are implemented on the ground. To control thermal expansion and shrinkage [of these pipelines], these conduits are implemented with expansion joints or as expansion rings or zigzag lines. Different types of on-ground pipes are shown in Figure 7-2.

	
A) On-ground pipeline with anchor systems	B) Pipeline crossing a river
	
C) On-ground pipeline with valve and junction	D) On-ground lines implemented on anchor equipments

Figure 7-2: Different types of on-ground pipelines

In order for the pipelines to cross rivers, existing bridges can be used while controlling the available bearing capacity. This reduces costs and facilitates maintenance.

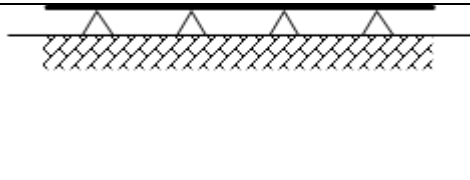
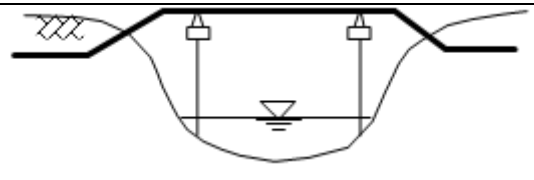
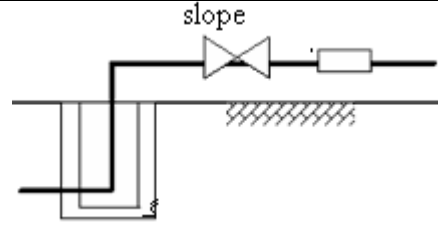
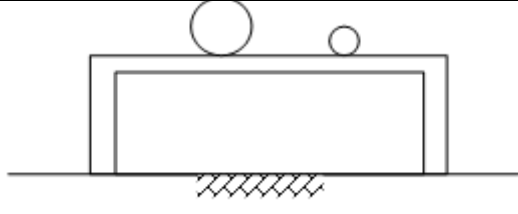

7-3-General considerations on seismic design of pipelines

- 1-Bodies and junctions of the pipes passing unstable grounds should have the enough capacity for bearing earthquake-induced forces and deformations. Structural stability of foundations or consolidation of the soil should also be planned for.
- 2-Synthetic grounds such as beaches or old rivers undergo large deformations during earthquake. Pipes that cross these grounds must have high deformation capacities.
- 3-Pipes that are placed above slopes should have the required resistance to slope slippage.
- 4-Due to the possibility of relative earthquake-induced ground displacements, pipelines should have enough capacity to absorb these displacements especially in special topographic conditions.
- 5-In liquefying grounds pipes have enough resistance.
- 6-In grounds adjacent to bank walls and coastal slopes a great deal of seismic resistance is needed.
- 7- Where crossing active faults is inevitable, absorption of deformation and energy should be made possible in the pipes. And if the pipes are damaged, either the functionality of the pipes is saved or an alternative system is provided to be employed during earthquake.
- 8-The junctions between the pipes and the structures should have the required deformation absorption capacity.
- 9-It is necessary to take careful considerations into account where pipes experience height variations (for example when parts of the pipes are placed into a vessel or common urban conduits) in order to bear the forced inertia force caused by earthquake in addition to the normal unbalanced force. Moreover, seismic arrangements, such as expansion joints and flexible joints (pipe), should be considered as well in sections where the possibility of an increase in the relative displacements of buried pipelines during does exist.
- 10-In the section of the pipeline that is affected by water dynamic pressure during earthquake, necessary arrangements shall be planned.
- 11-In arcs and flexures of disjoint pipes, bent pipe segments should be used to enhance ductility.
- 12-In the intersection of pipelines and roads, pipes shall be buried at the appropriate depths to prevent collision with other road components and also to make their repair and maintenance.
- 13-In underground intersections between the pipelines, a free distance of at least 30 cm should be reserved.
- 14-In order to examine the post-earthquake state of thick pipes walkways should be created in proper locations.
- 15-Valves should be installed at distances of 50 to 100 meters. Installation of emergency stop facilities is quite effective for dividing the functionality of the pipeline.
- 16-Using random flexures with large angles in the pipes should be avoided to the possible extent.

Description:

Seismic design of pipelines should be carried out by taking the geological and geographical characteristics [of the desired locations] into account. Suitable locations include:

- 1- Locations the geological and geographical characteristics of which are needed to be studied.

Since ground motions affect the behavior of pipelines and also because of the record of pipe damages during the past earthquakes, the following issues shall be carefully analyzed:

- 1-1-Embankment ground

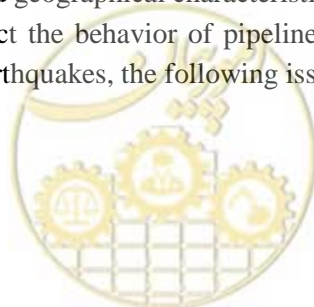

Embankments may undergo landslide, collapse, and intense movements due to the effects of earthquakes.

1-2-Synthetic ground

Synthetic grounds in the sea coasts, rivers and old tanks undergo liquefaction and displacement during earthquake.

1-3-Slope tops

In the upper areas of slopes landslide due to earthquake is inevitable.

1-4-loose and thick bottom layers

If the bottom layers are loose and thick, surface deformations can be considerable. In addition, a decline in the level of underground water and its consequent settlements in soft grounds intensify these deformations.

1-5-Geological and topographic changes in thin sections

Geological and topographic changes in thin and boundary sections between the beds and the alluviums can increase the potential for relative movements due to sudden changes in the conditions of the soil between ground layers.

1-6-Liquefying zones

If a layer of fine soil exists beneath the underground water level, the potential for liquefaction and lateral spreading will be high.

1-7-Grounds adjacent to protected beaches

In grounds adjacent to protected beaches if the protective walls fail to work intense lateral movements will occur.

1-8-Slopes

Slopes are highly prone to landslide during earthquake and can exert lots of external forces on pipelines.

1-9-Active faults

Active faults should not cut the lines as much as possible, otherwise providing enough flexibility will be necessary.

2- Zones in need of structural analysis

In some areas pipelines should be carefully examined for settlements and deformations. Such areas include:

2-1- The junction between the pipeline and the structure, which is the point of stress concentration and sudden deformations.

In these areas expansion and flexible joints can be used to reduce or prevent damages. If a problematic ground is in such a condition, the pipeline should be able to bear all the deformations.

2-2-Where the pipeline has height variations (such as when the pipeline is placed into a vessel or urban common conduits)

Where the pipeline reaches the shallow section from the deep section, displacement of the upper section in relation to the lower section should be considered as well.

2-3-The section that receives water dynamic pressure during earthquake

In the lower sections, the bending section and the T-shaped section, water dynamic pressure during earthquake should be taken into account.



7-4-Buried pipelines

7-4-1-Response displacement method for pipeline design

7-4-1-1-Seismic design input

Seismic input is expressed as the ratio of ground vibration in the bedrock (in terms of acceleration) to gravity acceleration.

This seismic input is called “design seismic coefficient in bedrock” and is obtained in this guideline in the section titled Seismic Loading of Lifelines.

7-4-1-2-Velocity spectrum

Velocity response spectrum, α_v , for the input gravity acceleration in the bedrock is discussed in the Iranian Guideline of Loading and Seismic Analysis of Lifelines.

7-4-1-3-Dominant ground period

See the relations introduced in the Iranian Guideline of Loading and Seismic Analysis of Lifelines.

7-4-1-4-Wavelength

Wavelength (L) is the result of horizontal progressive Rayleigh type surface wave. The apparent wavelength is, $L_A(m)$, is calculated using relation 7-1.

$$L_A = V \cdot T_p \quad (7-1)$$

Where $V(m/s)$ denotes the velocity of horizontal progressive wave and is obtained using the dispersion curve shown in Figure 7-3.

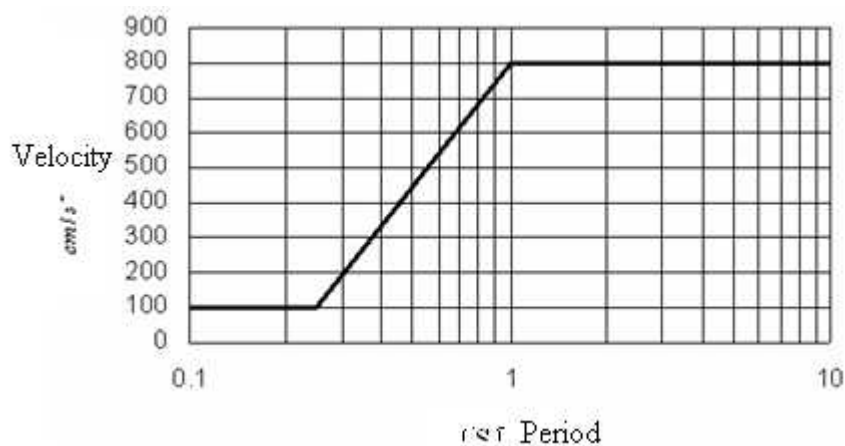

Figure 7-3: Scatter graph

7-4-1-5-Horizontal ground displacement

See section (3-2-3) of the Guideline of Loading and Seismic Analysis of Lifelines.



7-4-1-6-Vertical ground displacement

1-The range of vertical response displacement is obtained using relation (7-2):

$$U_v = \frac{1}{2} U_h \quad (7-2)$$

2-When ground motion is intensified due to abnormal ground conditions (including bedrock slope), the seismic coefficient is multiplied by 1.2 (1.2 K_{SH}).

7-4-1-7-Ground strain

Ground strain in the axial direction of pipes is calculated using relation 7-3.

$$\varepsilon_G = \frac{\pi U_h}{L} \quad (7-3)$$

Where:

ε_G : ground strain

U_h : range of ground horizontal displacement along the pipe axis (cm)
(See section 3-2-3 of the Guideline of Loading and Seismic Analysis of Lifelines.)

L : wavelength (cm)

Description:

Buried pipelines are of two types: disjoint pipelines and unbroken pipelines.

Buried unbroken pipelines are mostly constructed of welded concrete. Ductile iron pipes that are connected to each other using flanges (which is rarely done) behave similar to unbroken pipelines. Disjoint pipes are constructed of ductile iron pipes. Pipelines constructed of welded concrete with elastic junctions are considered to be disjoint pipelines.

7-4-1-8-Soil stiffness coefficient in the allowable stress method

In calculations of the allowable stress method, the slippage between soil and pipelines should be ignored. Stiffness coefficients of soil in the axial and transverse lines of pipes (K_{g1} , K_{g2}) are obtained from relations 7-4 and 7-5:

$$K_{g1} = C_1 \frac{\gamma_t}{g} V_s^2 \quad (7-4)$$

$$K_{g2} = C_2 \frac{\gamma_t}{g} V_s^2 \quad (7-5)$$

Where:

K_{g1} , K_{g2} : Stiffness coefficients of soil per unit length in the axial and transverse directions of the pipe (Pa).

γ_t : soil unit weight (N/m^3)

g : gravity acceleration (9.8 m/s^2)

V_s : velocity of elastic shear wave in the surface layer (m/s)

C_1 , C_2 : stiffness coefficients of soil in the axial and transverse directions

C_1 and C_2 are approximately equal to $C_1=1.5$ and $C_2=3$ but it is recommended to obtain the exact values using the finite element method. For example relations below are obtained using the finite element method by choosing the depth between 5 and 30 meters and diameter of pipeline between 150 and 3000 millimeters:

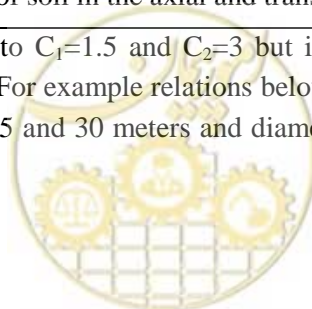

$$C_1 = 1.3H^{-0.4}D^{0.25} \quad (7-6)$$

$$C_2 = 2.3H^{-0.4}D^{0.25} \quad (7-7)$$

H : thickness of ground surface layer (m)

D : pipeline diameter (m)

7-4-1-9-Ground friction force in the plastic design method

In calculations of the plastic design method the slippage between the soil and the pipe should be taken into account. The friction between the soil and the pipe should be almost 0.01 MPa.

Description:

It is better to calculate the friction of critical pipelines using the nonlinear response analysis method.

7-4-2-Calculations of unbroken pipelines using the displacement response method

7-4-2-1-Overview

If the stress of strain of the pipe is obtained from the allowable stress method, the slippage between the soil and the pipe should be neglected. But in the plastic design method, the slippage between the soil and the pipe should be considered.

7-4-2-2-Calculation of pipe body stress in the allowable stress design method

The stress of pipeline body in the allowable stress design method can be calculated using relations below:

$$\sigma_{1L} = \alpha_1 \frac{\pi U_h E}{L} \quad (7-8)$$

$$\sigma_{1B} = \alpha_2 \frac{\pi^2 D U_h E}{L^2} \quad (7-9)$$

$$\sigma_{1X} = \sqrt{\alpha_{1L}^2 + \alpha_{1B}^2} \quad (7-10)$$

Where:

σ_{1L} : axial stress of buried pipeline (Pa)

σ_{1B} : bending stress of buried pipeline (Pa)

σ_{1X} : stress combined of axial stress and bending stress (Pa)

α_1, α_2 : transfer coefficients of ground displacements along the axial and transverse directions of the pipe. These coefficients are calculated as follows:

$$\left. \begin{aligned} \alpha_1 &= \frac{1}{1 + \left(\frac{2\pi}{\lambda_1 L} \right)^2} \\ \alpha_2 &= \frac{1}{1 + \left(\frac{2\pi}{\lambda_2 L} \right)^4} \end{aligned} \right\} \quad (7-11)$$



$$\left. \begin{aligned} \lambda_1 &= \sqrt[2]{\frac{K_{g1}}{EA}} (1/m) \\ \lambda_2 &= \sqrt[4]{\frac{K_{g2}}{EI}} (1/m) \end{aligned} \right\} \quad (7-12)$$

Where:

L' : apparent wavelength (m) ($\sqrt{2}L =$)

L : wavelength (m)

L_1, L_2 : stiffness coefficients of soil per unit length in the axial and transverse directions of the pipe (Pa)

K_{g1}, K_{g2} : elastic modulus of buried pipeline (Pa)

A : sectional area of buried pipeline (m^2)

I : moment of inertia of the pipeline (m^4)

U_h : horizontal ground displacement (m)

D : outer diameter of the buried pipeline (m)

E : elastic modulus of buried pipeline (Pa)

7-4-2-3-Calculation of the stress of unbroken pipe body (using the plastic design method)

1-Axial stress of pipe body is calculated as below.

$$\sigma_{2L} = \frac{\pi D \tau L'}{4A} \quad (7-13)$$

Where:

σ_{2L} : axial stress of the pipeline (Pa)

τ : stress due to the friction between the pipeline and the ground (Pa)

2-Bending and combined stresses should be obtained from relations 7-9 and 7-10.

7-4-2-4-Calculation of the strain of pipe body (Design of unbroken pipelines using the allowable stress method)

The strain of pipelines, such as steel pipes, should be calculated as below:

$$\varepsilon_{1L} = \alpha_1 \cdot \varepsilon_G \quad (7-14)$$

$$\varepsilon_{1B} = \alpha_2 \cdot \frac{2\pi D}{L} \varepsilon_G \quad (7-15)$$

$$\varepsilon_{1x} = \sqrt{\varepsilon_{1L}^2 + \varepsilon_{1B}^2} \quad (7-16)$$

ε_{1L} : axial strain of the pipeline

ε_{1B} : bending strain of the pipeline

ε_{1x} : combined axial and bending strain

ε_G : ground axial strain

α_1 : transfer coefficient of ground axial strain

$$\alpha_1 = \frac{1}{1 + \left[2\pi / (\lambda_1 L') \right]^2} \quad (7-17)$$



$$\lambda_1 = \left[K_{g1} / (EA) \right]^{1/2} \quad (7-18)$$

α_2 : transfer coefficient of ground transverse strain

(relation 7-11)

ε_{1L} is calculated using the previously explained method in elastic mode. But if ε_{1L} is larger than the yield strain of pipe, ε_y , it is calculated using the coefficient of transfer λ_1 , using relation 7-14.

$$\lambda_1 = \left[\left(K_{g1} / \left\{ \varepsilon_y / (2\varepsilon_{1L}) EA \right\} \right) \right]^{1/2}$$

Relations 7-8 to 7-10 are used for safety control of pipeline strain.

7-4-2-5-Calculation of the strain of pipe body in the plastic design method

Axial strain, ε_{2L} , should be calculated as follows:

$$\left. \begin{aligned} \varepsilon_{2L} &= L/\zeta & (L < L_1) \\ \varepsilon_{2L} &= L/(\kappa\zeta) & (L_1 \leq L < L_2) \\ \varepsilon_{2L} &= \varepsilon_{G\max} & (L_2 = L) \end{aligned} \right\} \quad (7-19)$$

$$L_2 = \kappa\zeta \left\{ \varepsilon_{G\max} - (1 + 1/\kappa)\varepsilon_y \right\} \quad (7-20)$$

$$\zeta = 2\sqrt{2} Et/\tau \quad (7-21)$$

Where:

t : thickness of buried pipeline (m)

κ : special rigidity in relation to the strain of buried pipeline ($k=0.1$)

ε_y : yield strain of buried pipeline

$\varepsilon_{G\max}$: ground strain at $S_{V\max}$ (S_V ' if $T_G \geq 0.7$)

Bending and combined strains should be obtained from relations 7-15 and 7-16.

7-4-3-Calculations of disjoint pipelines using the displacement response analysis method

7-4-3-1-Overview

- 1-Disjoint pipelines should be basically designed using the plastic design method. If the stress and strain calculated for the pipe are less than those corresponding to the lower limit of earthquake, the slippage between the soil and the pipe must be neglected. Otherwise, the slippage between the soil and the pipe should be taken into account.
- 2-The lower limit of seismic coefficient is obtained by employing risk level 2.
- 3-Junction displacements and bending angles should be chosen from the horizontal ground displacement range.

7-4-3-2-Calculation of the stress of pipe body (disjoint ductile iron pipeline regardless of slippage)

Pipe strain is calculated as below regardless of the slippage between the pipe and the soil:

$$\sigma'_{1L}(x) = \zeta_1(x) \cdot \sigma_{1L} \quad (7-22)$$

$$\sigma'_{1B}(x) = \zeta_2(x) \cdot \sigma_{1B} \quad (7-23)$$



$$\sigma'_{ix}(x) = \sqrt{\{\sigma'_{il}(x)\}^2 + \{\sigma'_{ib}(x)\}^2} \quad (7-24)$$

$\sigma'_{ib}(x)$, $\sigma'_{il}(x)$:bending and axial stresses (Pa)

$\sigma_{il}(x)$, $\sigma_{ib}(x)$:bending and axial stresses obtained from relations 7-8 and 7-9 (Pa)

$\sigma'_{ix}(x)$: combination of axial and bending stresses at point x (m) in relation to flexible junctions in the axial direction of the pipe (Pa)

$\zeta_1(x)$, $\zeta_2(x)$:modification coefficients of buried pipes where junctions are unbroken (so that by assuming rigid junctions disjoint pipes can be considered as unbroken pipes)

In relation 7-24, it is better to multiply $[\sigma'_{il}(x)]^2$ by 3.12 to 1.00 depending on the importance of the pipeline.

7-4-3-3-Calculation of the stress of pipe body (disjoint ductile iron pipeline by considering the amount of slippage)

In this case axial stress, σ'_{2L} , should be obtained by non-linear analysis. For ductile iron pipelines, the calculations below can be useful. These relations are obtained by assuming the occurrence of moderate or severe earthquakes.

$$\sigma_L = \frac{\pi \cdot D \cdot \tau \cdot l}{2A} \quad (7-25)$$

Where :

σ_L : axial stress (Pa)

l : pipeline length (m)

A : pipe sectional area (m²)

Combined and bending stresses should be calculated using relations (7-23) and (7-24).

7-4-3-4-Calculation of the stress of pipeline (disjoint steel pipeline regardless of slippage)

The axial strain of a pipeline with flexible junctions during an earthquake with risk level 1 is calculated as below:

$$\varepsilon'_{il}(x) = \zeta_1(x) \cdot \varepsilon_{il} \quad (7-26)$$

$$\varepsilon'_{ib}(x) = \zeta_2(x) \cdot \varepsilon_{ib} \quad (7-27)$$

$$\varepsilon'_{ix}(x) = \sqrt{\{\varepsilon'_{il}(x)\}^2 + \{\varepsilon'_{ib}(x)\}^2} \quad (7-28)$$

Where:

$\varepsilon'_{il}(x)$, $\varepsilon'_{ib}(x)$: axial and bending strains at a point (m) of flexible junctions in the axial direction of the pipe

ε_{il} , ε_{ib} : bending and axial strains are calculated using relations 7-14 and 7-15.

$\varepsilon'_{ix}(x)$: combined axial and bending strains at point x (m) of flexible junctions along the axial direction of the pipe

$\zeta_1(x)$, $\zeta_2(x)$: modification coefficients of the buried pipe assuming that its junctions are unbroken (so that by assuming rigid junctions, the disjoint pipe can be considered as an unbroken pipe)

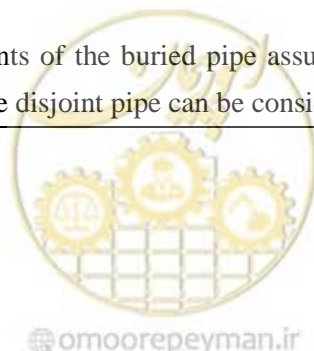

7-4-3-5-Calculation of the strain of disjoint pipe (disjoint pipeline considering the amount of slippage)

Axial strain, ε'_{2L} , is obtained as follows:

$$\varepsilon'_{2L} = \frac{\tau L_e}{2Et} \quad (7-29)$$

Where:

L_e : distance between junctions in the flexible pipe

(m)

t : thickness of buried pipeline (m)

Bending and combined stresses shall be calculated using relations 7-27 and 7-28.

7- 4-3-6-Calculation of the axial displacement of junctions

Axial displacement of junctions is calculated as below:

$$|u_J| = u_0 \bar{u}_J \quad (7-30)$$

Where:

$|u_J|$: axial expansion of joints (m)

u_0 : relative axial displacement of beams by assuming beams with infinite lengths (m)

$$\bar{u}_J = \frac{2\gamma_1 |\cosh \beta_1 - \cos \gamma_1|}{\beta_1 \sinh \beta_1} \quad (7-31)$$

$$u_0 = \alpha_1 U_a \quad (7-32)$$

$$\alpha_1 = \frac{1}{1 + (\gamma_1/\beta_1)^2} \quad (7-33)$$

$$\beta_1 (= \lambda_1 l) = \sqrt{\frac{K_{g1}}{EA}} \cdot l \quad (7-34)$$

$$\gamma_1 = \frac{2\pi l}{L'} \quad (7-35)$$

Where:

EA : tensile rigidity (N)

L : distance between junctions (m)

K_{g1} : soil stiffness in the axial direction of the pipe (Pa)

L' (m)($\sqrt{2L}$ =): apparent wavelength

L : wavelength (m)

U_a : horizontal ground displacement in the axial direction (m)

$$U_a = \frac{1}{\sqrt{2}} U_h \quad (7-36)$$

Where:

U_h : horizontal displacement at a depth of x (m) into the ground

Calculations of cast iron pipes that are subjected to moderate and severe earthquakes are done using relation 7-37.

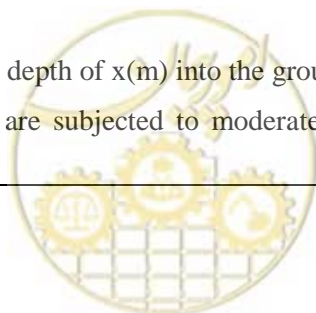

$$e_p = \varepsilon_G l \quad (7-37)$$

Where:

e_p : joint expansion in the axial direction (m)

ε_G : ground strain

The flow (process) of calculating the axial expansion of joints is illustrated in Figure 7-4.

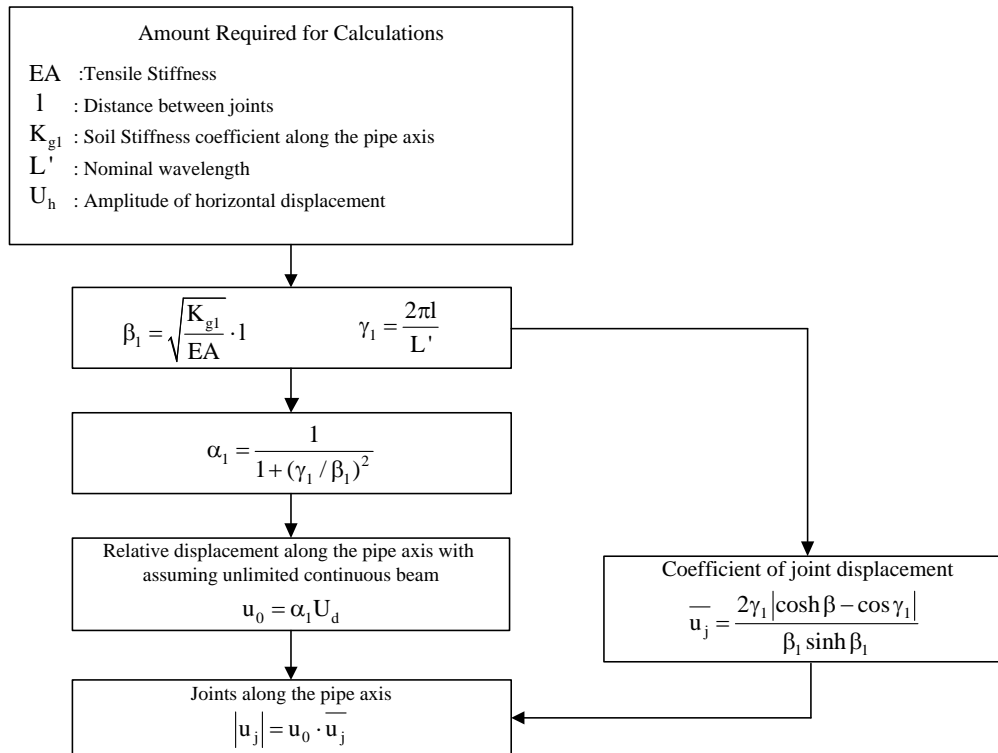

Figure 7-4: Flow of calculating the axial expansion of joints

7-4-3-7-Calculation of the bending angle of junctions

Bending angle is obtained using the relation below:

$$\theta = \frac{4\pi^2 l U_h}{L^2} \quad (7-38)$$

Where:

θ : bending angle of junctions (rad)

U_h : horizontal displacement at a depth of x (m) into the ground (m)

Description:

Here it is assumed that displacement of the pipeline is similar to ground displacement. These calculations are applicable for different risk levels.

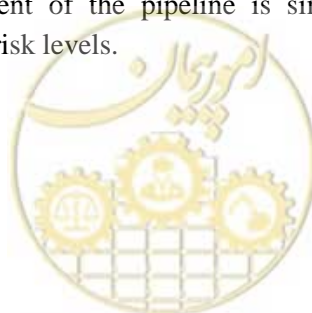

7-4-4-Calculation and safety control of permanent ground displacement beneath pipelines

7-4-4-1-Overview

Permanent ground displacement is an important risk for pipelines. Maximum ground strains at boundary conditions are the benchmarks for determining the maximum ground displacement. When the ground is liquefying this boundary will be the point of contact between the liquefying and non-liquefying layers. In the case of faults maximum displacement occurs in the fault and ground fracture. In this case, slippage is the displacement at the edge of slopes and the maximum settlement depends on the settlement pattern.

7-4-4-2-Arrangements against PGD¹ in disjoint pipelines

Expansion and unbreakable joints (expansion displacement: pipe length $\pm\beta\%$) should be employed to prevent displacement and rupture of straight pipelines. In sections subject to bending forces (such as building gates and junction boxes) highly flexible expansion clamping joints (expansion size: pipe length, $\pm\alpha$, M, bending angle, deg $\pm\theta$) are used.

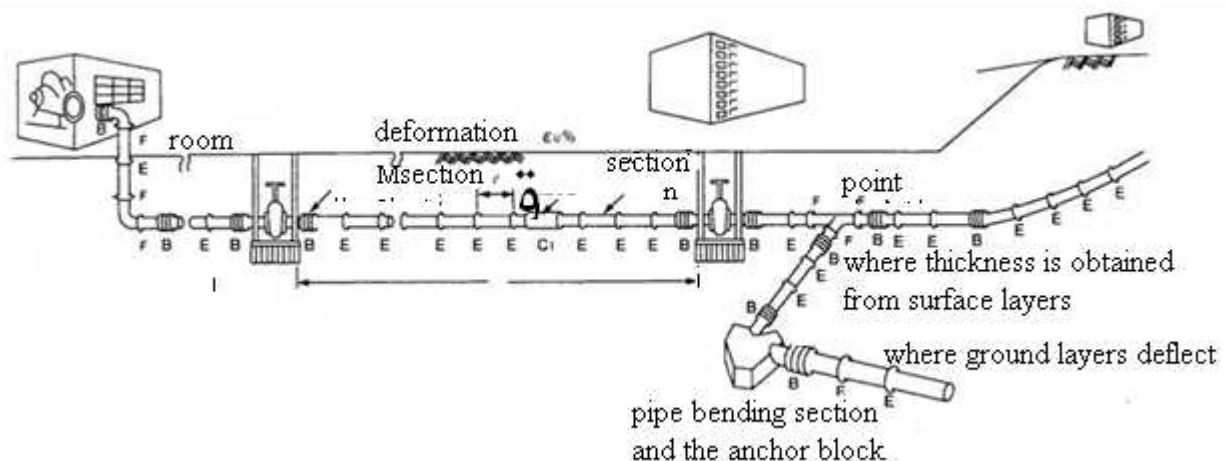

Figure 7-5: Schematic of a disjoint pipeline

7-4-4-3-Calculations of disjoint pipelines subject to liquefaction effects

To ensure the safety of a pipeline with a length of L that the length of each its sections are denoted by l (small L) and the joints of which are of types E and B , the axial displacement capacity of the pipe must be more than the maximum ground displacement ($\epsilon_G L$):

$$\epsilon_G L < n\beta l + Ma \quad (7-39)$$

Where:

N : the number of expansion joints with a longitudinal tolerance of $\pm\beta\%$ along the pipe length (tolerance is defined by the manufacturer)

M : the number of flexible clamping joints with a circular tolerance of $\pm\theta$ and axial tolerance of $\pm\alpha$ (tolerance is defined by the manufacturer)

If the above conditions are not satisfied, pipeline flexibility and its displacement absorption capacity should be

¹ Permanent ground displacement (PGD)

increased by adding flexible long junctions (C_1). The number of these junctions is obtained from the following relation:

$$N = \frac{\varepsilon_G L - n\beta l - Ma}{b} \quad (7-40)$$

Where for common junctions we have:

E : expansion joints (with longitudinal tolerance of $\pm \pm\beta\%$ along the pipe length)

B : flexible clamping joints (with circular tolerance of $\pm \pm\theta$ and axial tolerance of $\pm\alpha$)

C_1 : anti-rupture flexible long joint with a tolerance of $\pm b$ (tolerance is defined by the manufacturer)

The tolerable capacity of each joint must be more than the transmission friction force exerted on the pipe. In the vertical direction of the pipeline also required controls over deformation tolerance should also be carried out. In the below figure the performance of disjoint expansion joints is depicted.

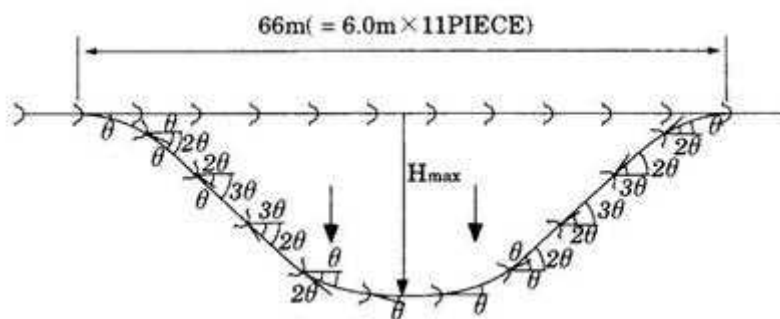

Figure 7-6: Behavior of disjoint pipeline along the direction perpendicular to the pipe axis

$$H_{\max} = l(\tan \theta + \tan 2\theta + \tan 3\theta + \dots + \tan 3\theta + \tan 2\theta + \tan \theta) \quad (7-41)$$

Where:

θ : maximum bending moment of each joint (deg)

7-4-4-3-1-Lateral ground displacement next to the retaining wall

When lateral ground displacements occur and axial deformations happen in the pipe, the maximum pipe strain is obtained from relation 7-42:

$$\varepsilon_p = \frac{\tau' L}{Et} \quad (7-42)$$

Where:

ε_p : axial strain of steel pipe

τ' : ground friction during liquefaction (Pa)

L : displacement length (m)

E : elastic modulus of steel pipe (21×10^{11} Pa)

t : thickness of steel pipe (m)

If ε_p exceeds its corresponding strain resulted from relation 7-42, strain of steel pipe should be obtained using relation 7-43.

$$\varepsilon_p = \frac{\tau' L}{\kappa Et} + \left(1 - \frac{1}{\kappa}\right) \varepsilon_y \quad (7-43)$$

κ : amount of strain hardening under stress. ($\kappa=0.01$)



7-4-4-3-2-Lateral displacement of slope ground

In sloped grounds where pipes are located perpendicular to the slope, the bending angle of straight pipes is obtained from relation 7-44 in terms of degrees:

$$\omega_s = \frac{180}{\pi} \cdot 127 \cdot D \sqrt{\frac{D \cdot \gamma_k \cdot \sigma_c \cdot \gamma_\delta \cdot \delta_h}{EI}} \quad (7-44)$$

Where:

D: outer pipe diameter (m)

γ_δ : minor safety factor associated with permanent ground displacement δ_h

γ_k : minor safety factor associated with soil stiffness, K_1

σ_c : soil compressive stress

The above factors are obtained from Table 7-1.

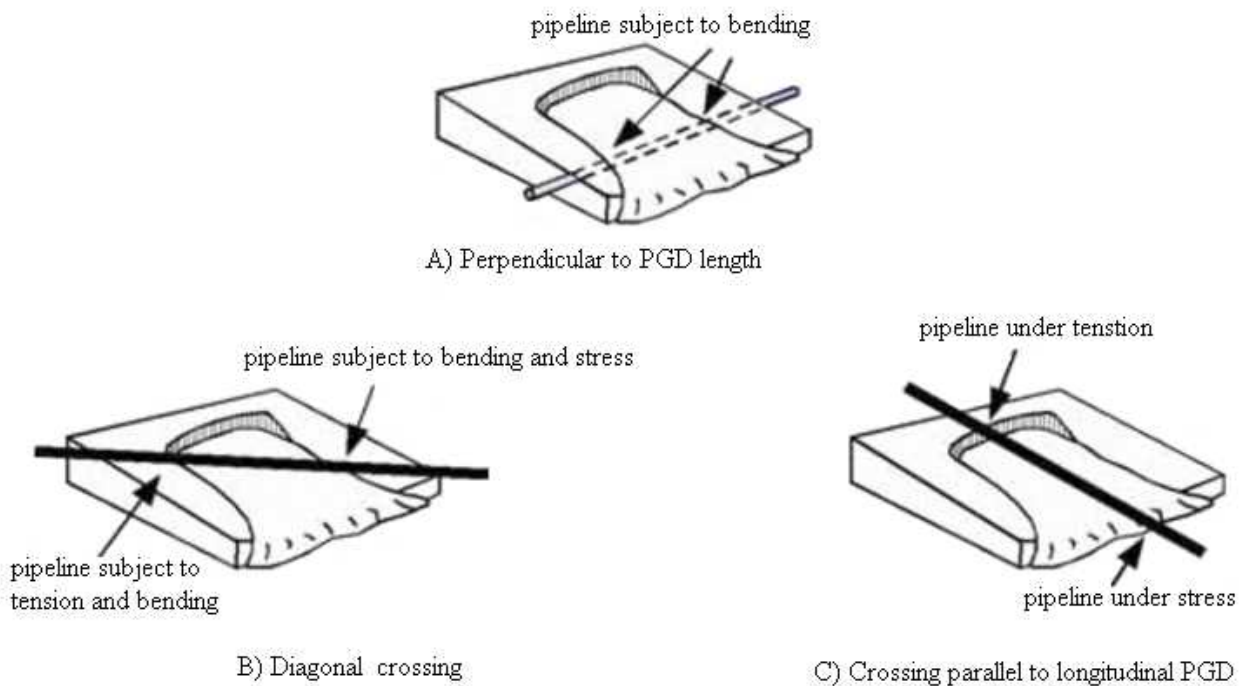

Figure 7-7: Different modes of pipeline crossing a liquefying zone

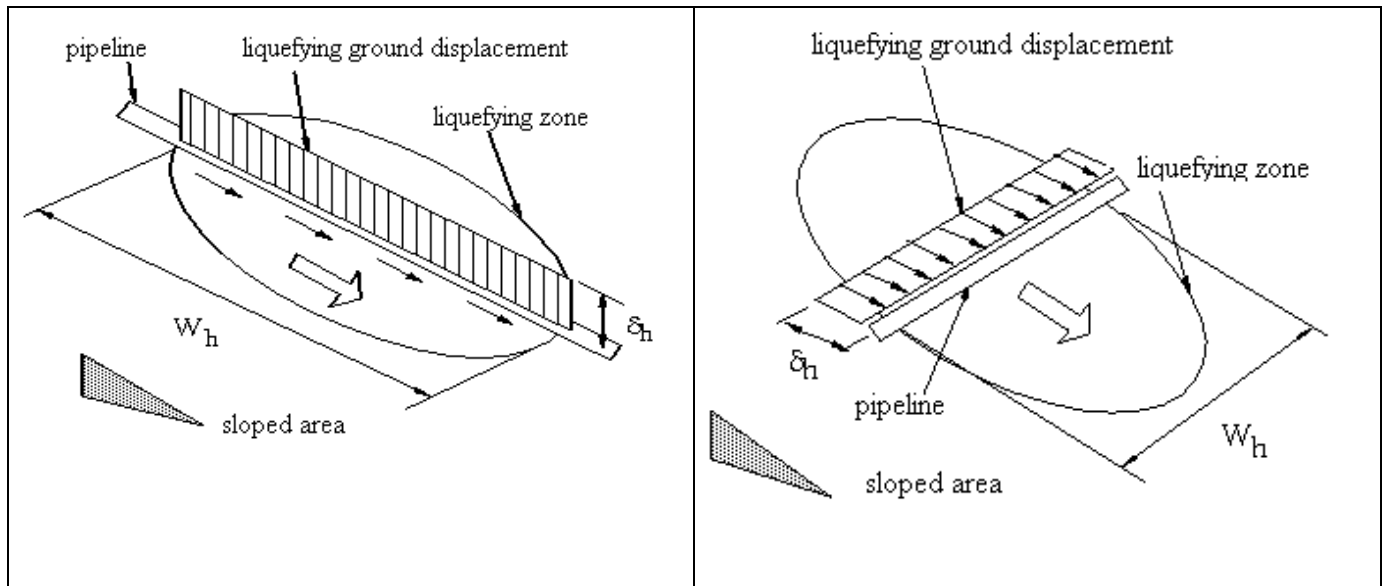

Figure 7-8: analysis model for straight pipes in sloped areas and liquefying grounds

7-4-4-3-3-Evaluation of seismic safety for liquefaction-induced permanent ground displacements

- 1-Seismic safety in this case is evaluated through probabilistic estimation of the serious case of the pipe under liquefaction-induced permanent displacements.
 - 2-This evaluation method is used for straight pipes and flexures.
 - 3-Evaluations of the minor safety factors of loads, structural analysis, aggregates characteristics and structural members are carried out separately.
- Common values of minor safety factors are included in Table 7-1.



Table 7-1: Minor safety factors

Minor safety factors			Members	Displacement mode	Standard value
Load coefficient	γ_{δ} for ground displacement	Slope	Pipe and flexure	All modes	1.8
		Bank wall			1.3
		Settlement			1
	γ_k for ground resisting force	Axial	Pipe and flexure	All modes	1.2
		Transverse			1.2
		Vertical			1.1
Coefficients of structural analysis	γ_a for simplification of design relations	Analytical relation	Pipe and flexure	Axial and bending buckling	1
		Non-elastic analysis through FEM	Pipe	Internal bending and external tension	1.1
			Flexure	Internal flexure and growth of external length	1
		Combined analysis of beam and shell	Pipe and flexure	All modes	1
Aggregates coefficients	γ_m for limit strain of pipe aggregates		Pipe and flexure	All modes	1
Coefficients of members	γ_{δ} for formulation of the critical displacement of pipe		Pipe	Axial and bending buckling	1
			flexure	Internal flexure and external strain	1



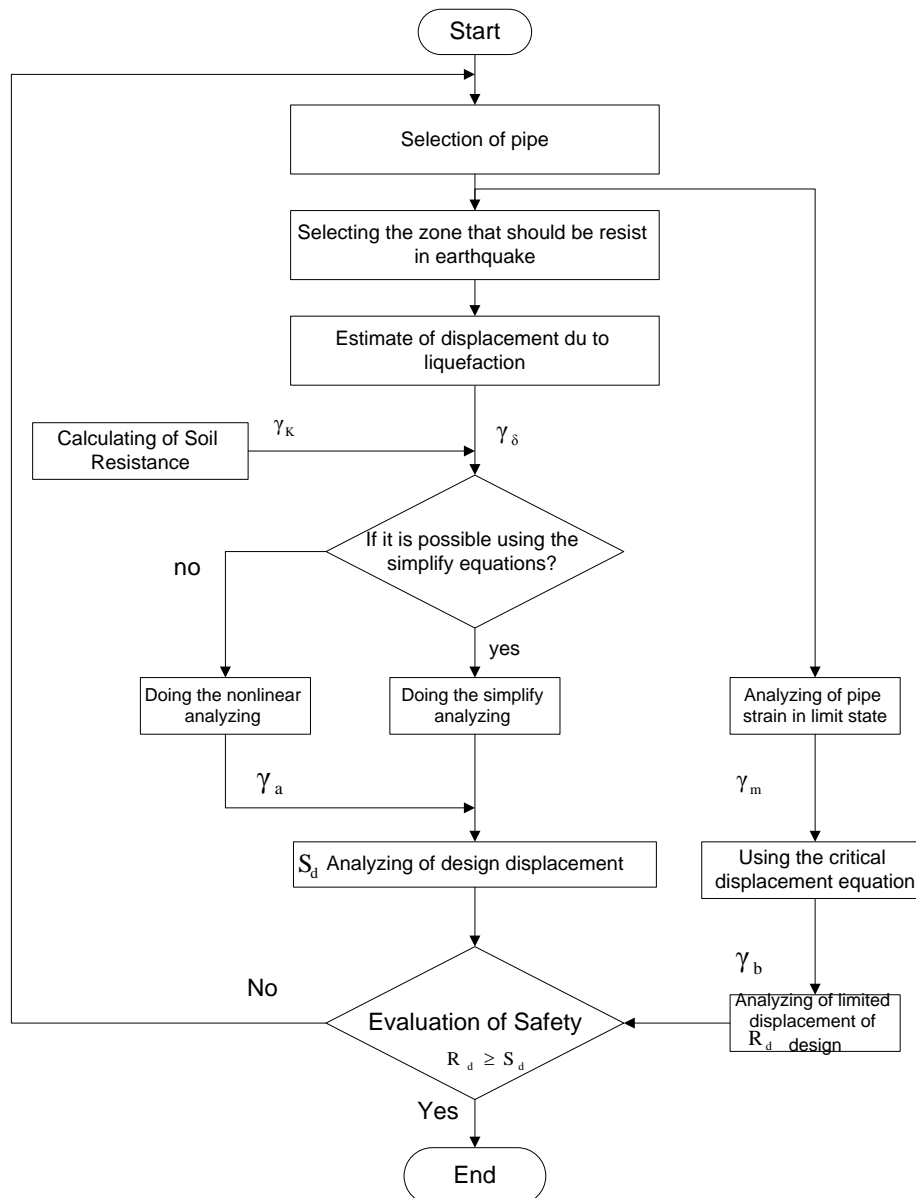

Figure 7-9: Application of minor safety factors

7-4-4-5-Calculation of pipe strain due to fault displacement

Pipe strain due to permanent displacements, PGD (m) caused by faults, is obtained as:

$$\varepsilon_{\text{pipe}} = 2 \left[\frac{\text{PGD}}{2L_a} \cos \beta + \frac{1}{2} \left(\frac{\text{PGD}}{2L_a} \sin \beta \right)^2 \right] \quad (7-45)$$

β and L_a denote the operating displacement angle along the pipe axis and effective length of the pipeline under displacement.

Description:

If the pipeline crosses a fault, the following considerations shall be taken into account otherwise site-specific studies shall be conducted, which can lead to an increase in pipe thickness and toughness, modification of welds, modification of the earthwork method, burial of on-ground pipes (through creation of embankments), design of supporting structures and modification of bearings:

ground displacement, surface topography, width of fault zone, soil conditions, erosion and drainage conditions, environmental impacts, proximity to other structures and associated costs.

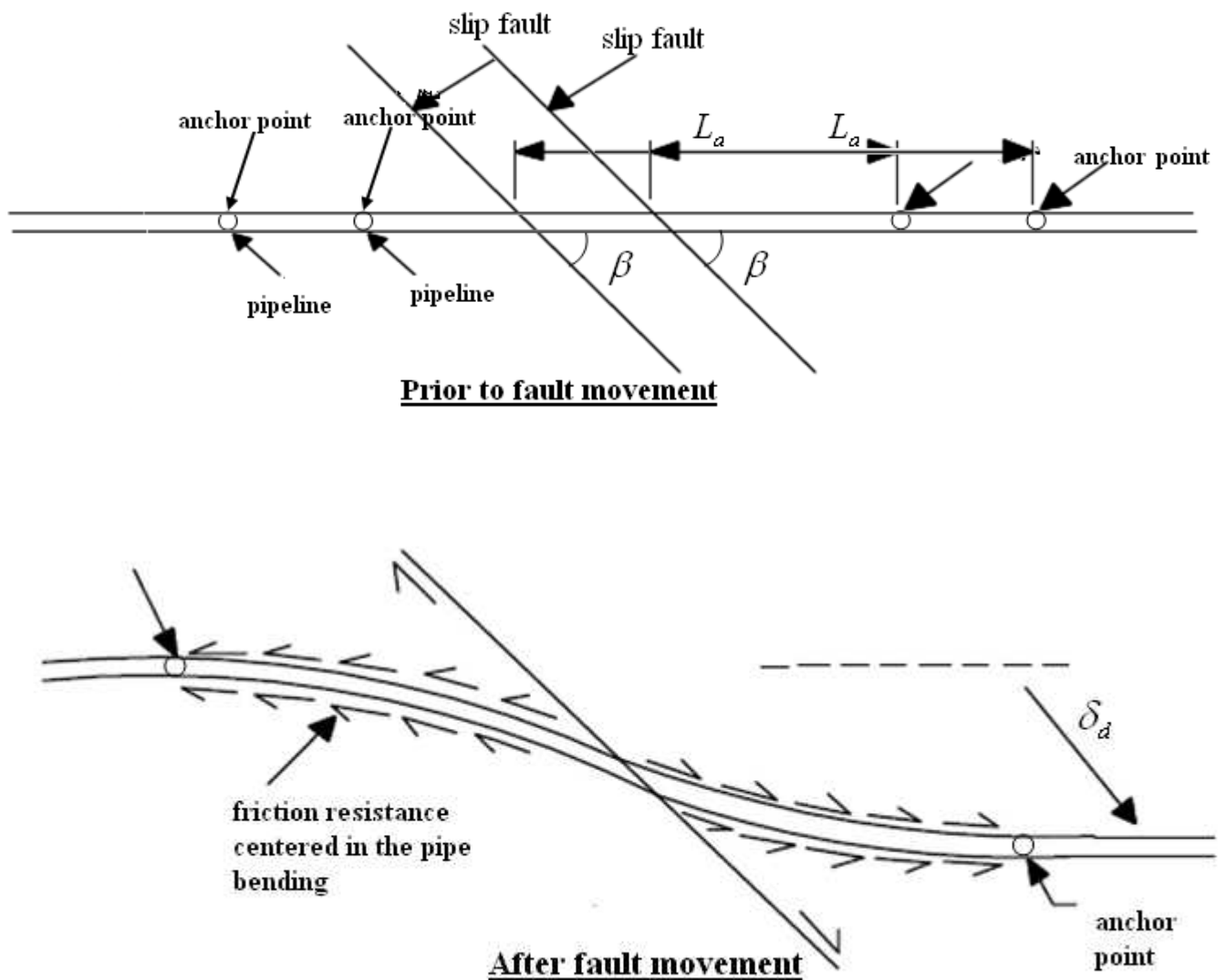

Figure 7-10 intersection between a pipe and a fault

7-4-4-6-Calculations related to landslide

7-4-4-6-1-Overview

Earthquake can lead to landslide and liquefaction in slopes and also movement of hills. It can also damage pipes by causing excessive displacement. In such a case permanent ground displacement, PGD, is considered along the slopes and pipe behavior will be also dependent on its alignment angle.

- Pipes along the PGD are affected by axial deformation.
- Diagonal pipes are affected by bending.

Description:

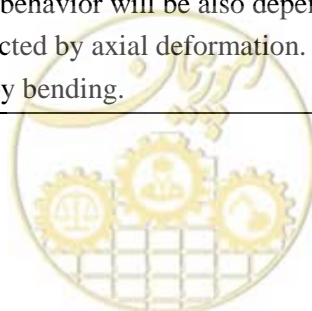

The equal static method (ESM) is not applicable in such conditions. Axial PGD usually damages the pipes naturally 5 to 10 times more than other displacements because pipes subject to strain show more deformation than pipes subject to pressure or tension.

The equal static method (ESM) can be used for pipes subject to minor displacements but in the case of large displacements (for example approximately 30 centimeters or more) analysis of finite elements shall be carried out with more precision.

7-4-4-6-2-Buried pipes response to longitudinal PGD

Axial displacement of a pipe can cause strain in the upper part of the slope and pressure in the lower part (correspondingly points A and B in Figure 7-11), which usually dominates the design.

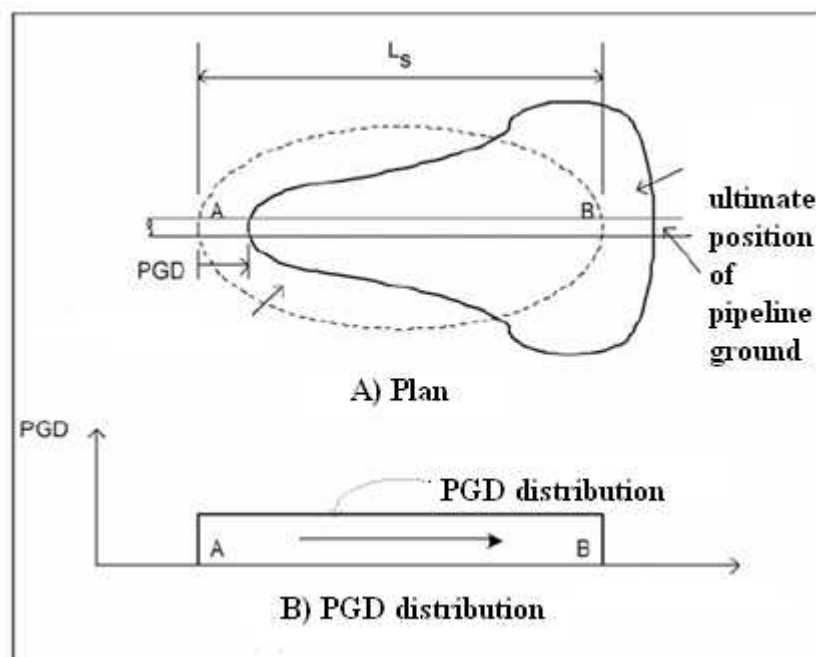

Figure 7-11: Buried pipes responses to longitudinal PGD

Design force is equal to the minimums of forces F_1 and F_2 . Force F_1 acts in the elastic zone of a pipe and has full interaction with the soil while force F_2 is the ultimate transferable load between the pipe and the soil.

$$F = \min(F_1, F_2) \quad (7-46)$$

Where:

$$F_1 = \sqrt{A_r E t_u \delta} \quad (7-47)$$

Where δ is the PGD type displacement, A_r denotes pipe area, E is the elastic modulus and t_u is the thickness.

$$F_2 = \frac{t_u L_{sp}}{2} \quad (7-48)$$

Where L_{sp} is the length of the pipe in a hill subject to displacement.

Description:



Where the elastic design method is not applicable the plastic design method can be employed. In such a condition the pipe should be constructed of ductile aggregates and its joints shall be capable of bearing acting forces.

7-4-4-6-3-Buried pipes response to transverse PGD

In such a case, the pipe acts as a beam under maximum displacement in the middle of the span (Figure 7-12).

Distributed PGD has the maximum displacement near the center and the minimum displacement near hill boundaries. The worst case occurs near hill boundaries, for example at the proximity of a pipe crossing a fault. The point of effect of maximum displacement is the mass center of the displaced hill. Determining the location of boundaries is of great importance in the effective design of areas with PGDs near hill boundaries. In such occasions site-specific hazards are also studied.

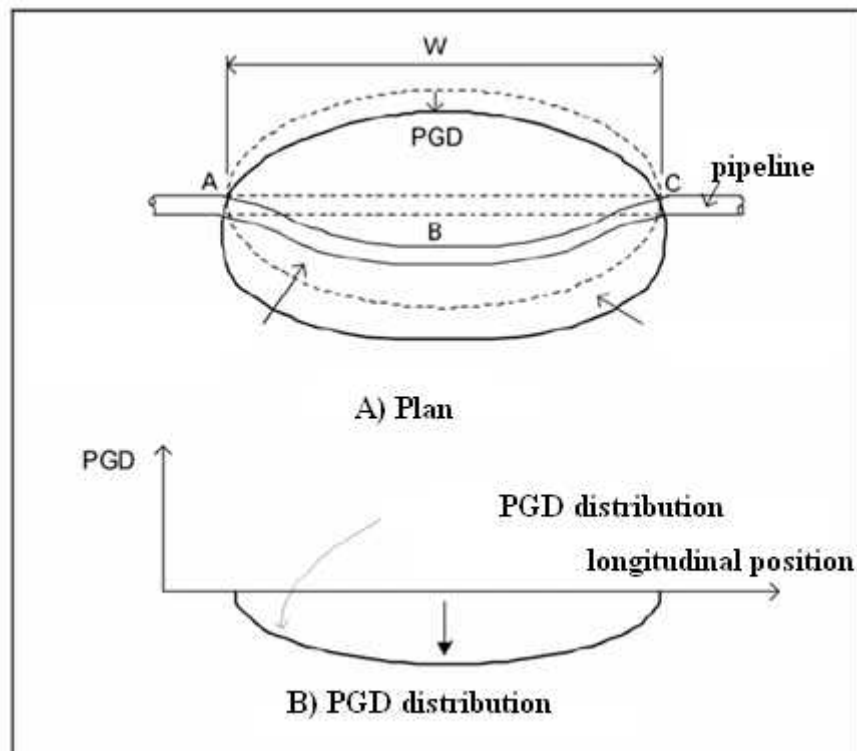

Figure 7-12: Buried pipes response to transverse PGD

Maximum strain of the pipe happens in the middle or at the end of its bending span (points A, B, and C in Figure 7-13). The conservative minimum strain is also obtained from relation 7-49:

$$\varepsilon_b = \pm \frac{\pi D_o \delta}{W_G^2} \quad (7-49)$$

Where W_G is the hill width, D_o is the outer pipe diameter and δ is the maximum PGD.

Description:

If the pipe is subjected to excess strain and it leads to its crush or buckling, it is recommended to use more exact finite element analyses. In order to do this the values of W and δ should be calculated based on site conditions. By using this method the pipe can be provided with the tolerance of plastic deformations. Of course the pipe aggregates should have the tolerance of plastic deformations as well.

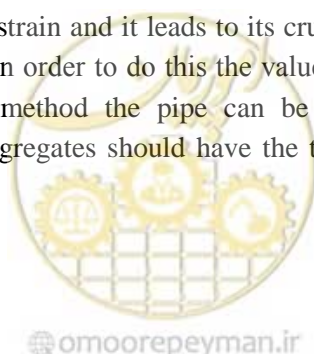

This capacity is 4 to 5% for tension and 1% for pressure without emergence of fracture. Pipe joints should also have the required resistance to fracture.

7-4-4-7-Special conditions for pipes

For pipes in complex systems the finite element analysis method shall be employed. The equivalent spring models for longitudinal, transverse and vertical directions are some of the available models.

1-When the pipeline is excited by waves

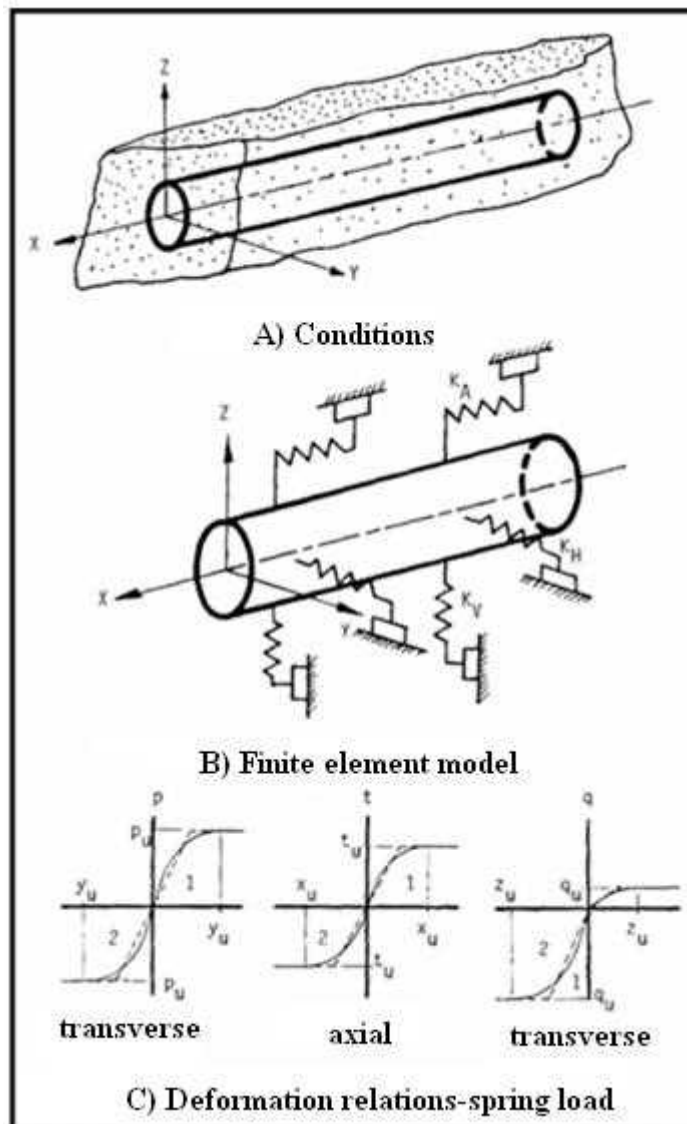

Figure 7-13: Modeling pipes using FEM finite element method for wave effects

2-When the pipeline crosses a fault zone.



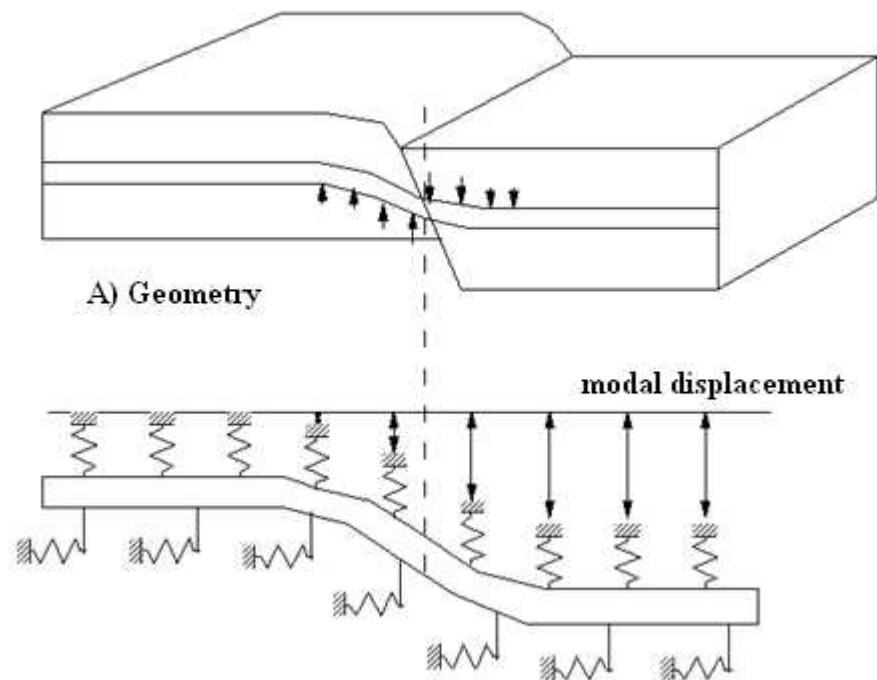

Figure 7-14: Modeling pipes using the finite element method when the pipeline crosses a fault

3-When the pipeline crosses a landslide zone.

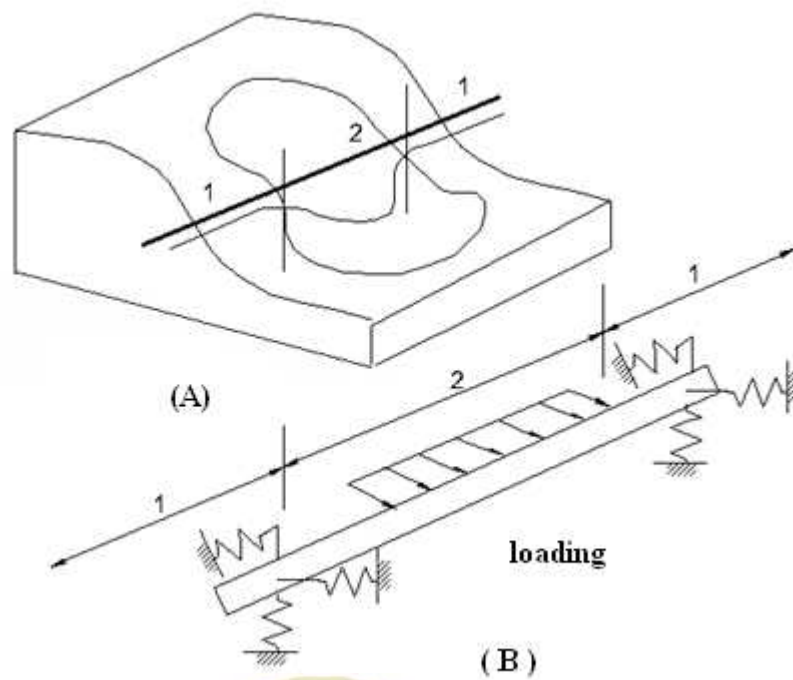
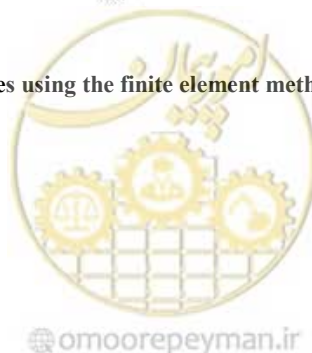

Figure 7-15: Modeling pipes using the finite element method when slope slippage happens



7-4-5-Calculations of shafts, conduits, common channels, and bucklers using the seismic coefficient and the displacement response analysis methods

- 1-Seismic calculations of shafts should be carried out using the quasi-static method and the displacement response analysis method.
- 2-If needed, safety control should be performed along with dynamic analysis. When the rigidity of the structures connected to the shaft is almost equal to that of the shaft, seismic calculations should be carried out based on the type of the structure.
- 3-Seismic calculations of conduits, normal channels and bucklers should be carried out according to the related standards and regulations.

1-Elastic calculations are done in the design of shaft sections using earthquake with risk level 1. Sectional stress of side faces of shafts is calculated using the seismic calculation method to ensure adequate safety of the shafts against the stress caused during earthquake. The quasi-static method, the displacement response analysis method and non-linear calculations are carried out using the dynamic analysis method for earthquakes with risk level 2. Here the combined load should be taken into account for safety control purposes. Safety control should be performed in the limit state and according to the guideline of concrete structures.

When the rigidity of shaft joints is low, it can be ignored for calculation purposes. In this model the quasi-static method and the displacement response analysis method are employed. Applied loads are calculated using as follows.

If displacement occurs in the ground surface and near shafts, horizontal loads act on side faces of the shaft from the underneath.

$$q_H(x) = k_H(x) \{u_H(x) - u_H(h_B)\} \quad (7-50)$$

Where:

$q_H(x)$: horizontal load at depth x (N/cm²)

$k_H(x)$: coefficient of ground horizontal response at depth x (cm)

$u_H(x)$: width of ground horizontal displacement at depth x (cm)

$u_H(h_B)$: width of ground horizontal displacement at depth h_B (cm)

Three approaches are available regarding side faces, the safest of which shall be chosen. These approaches are based on the chemistry of the connection between the side faces of the structure and the ground. The first approach is based on the assumption that displacement is very slight and the side faces do not emerge from the ground. Therefore the aforementioned calculations can be used. The second approach is based on the assumption that the side faces of the shaft are affected by no forces because the ground does not show resistance to tensions. The last approach is based on the assumption that part of the allowable earth pressure acts on side faces as the response of the ground. The designer should choose the safest approach.

In the quasi-static method calculations should be carried out according to one of the seismic design methods for box foundations. According to the rigidity of shaft joints, when the shafts do not have various levels of rigidity the related regulations and guidelines should be considered as the references and calculations should be controlled using the dynamic analysis method. Structures connected to the shafts should be considered as well.

2-The displacement response analysis method is basically used in seismic calculations of conduits, common channels, and bucklers. To design conduits and normal channels follow the related guidelines.

Seismic calculations of conduits, common channels and bucklers are mainly done based on assumed seismic coefficients corresponding to risk levels of earthquake.

2-1-In buildings that are designed by the existing methods, the allowable calculated limits are not adequately safe against stronger operating earthquake forces (such as for risk level 2). Therefore, it is recommended to carry out dynamic analysis for different risk levels.

2-2-The recent calculation methods that are commonly employed will be introduced later on. In analytical methods, T-tunnels are modeled by assuming the elastic behavior of ground and are considered as beams, the rigidity of the ring sections of which declines along the axial direction.

The strain of connector plates is considered in the axial direction due to the decline in rigidity. Here we refer to some studies conducted on the joints between segments:

a) The study conducted by Koizumi, Murakami, and Nishino

In this study, each joint is modeled according to the transform method used for finite structural modeling. Then the suitability of the model is examined based on the tests results.

- Modeling joints

Segment joints: these joints can be evaluated according to bending movement of circular springs.

Loop joints: these joints can be modeled using a method similar to that of segment joints. Although here in addition to modeling joints based on bending movements, circular, axial and shear springs are also modeled.

- Modeling T-tunnels

In modeling segment joints with different types of springs, T-tunnels can be installed according to Figures 7-16 and 7-17. When bodies of components are constructed of steel, the three-dimensional (3D) frame structural model is employed. For simple concrete components, the 3D cylindrical shell model is used. The model introduced in Figure 7-18 is proposed as an alternative model.



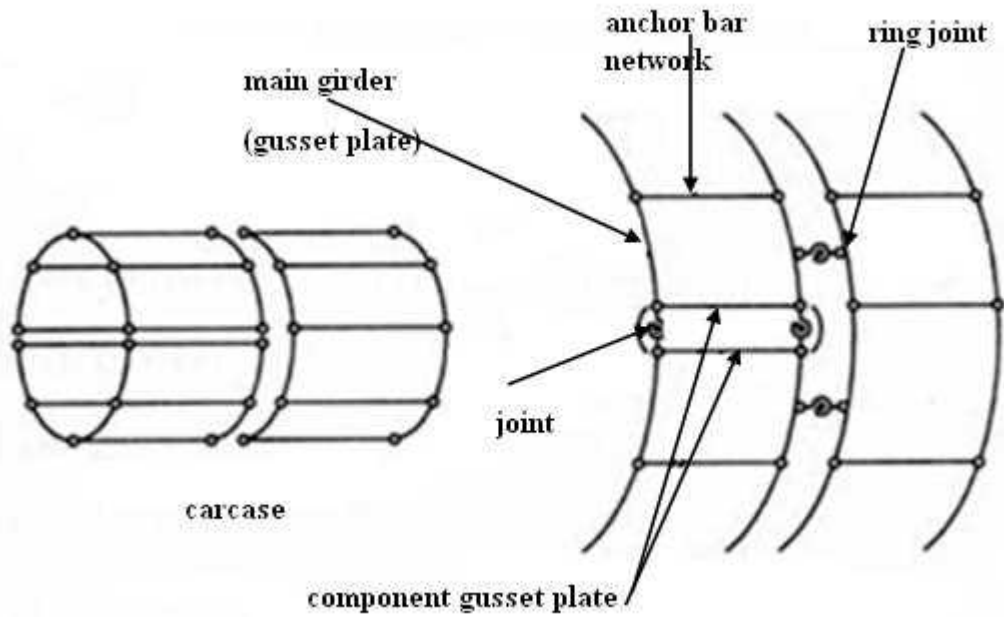

Figure 7-16: Construction model for framed spaced bucklers in T-tunnels

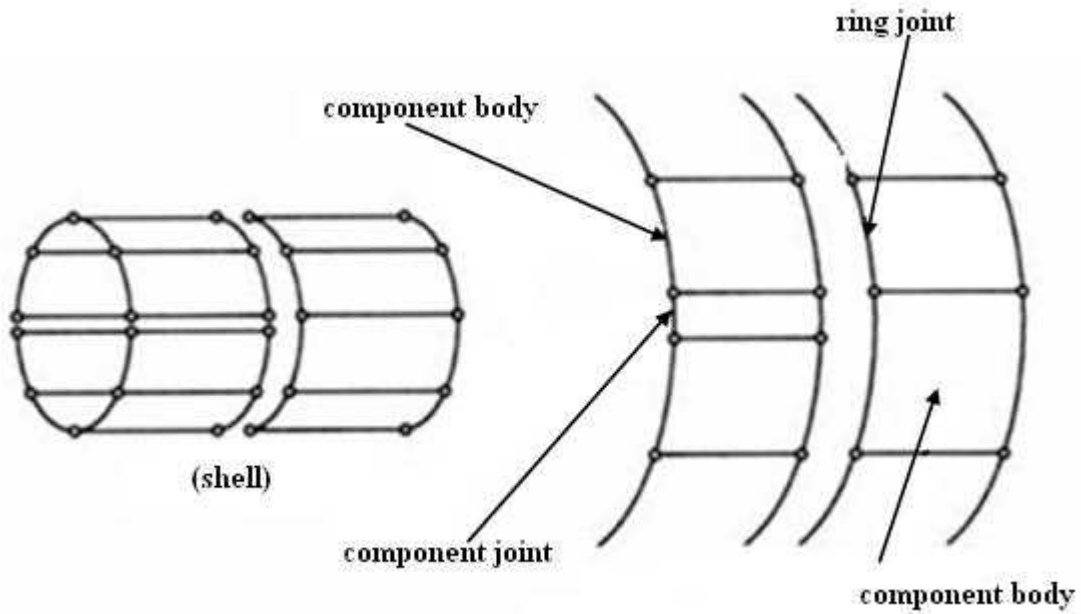

Figure 7-17: Construction model for cylindrical spaced bucklers in T-tunnels



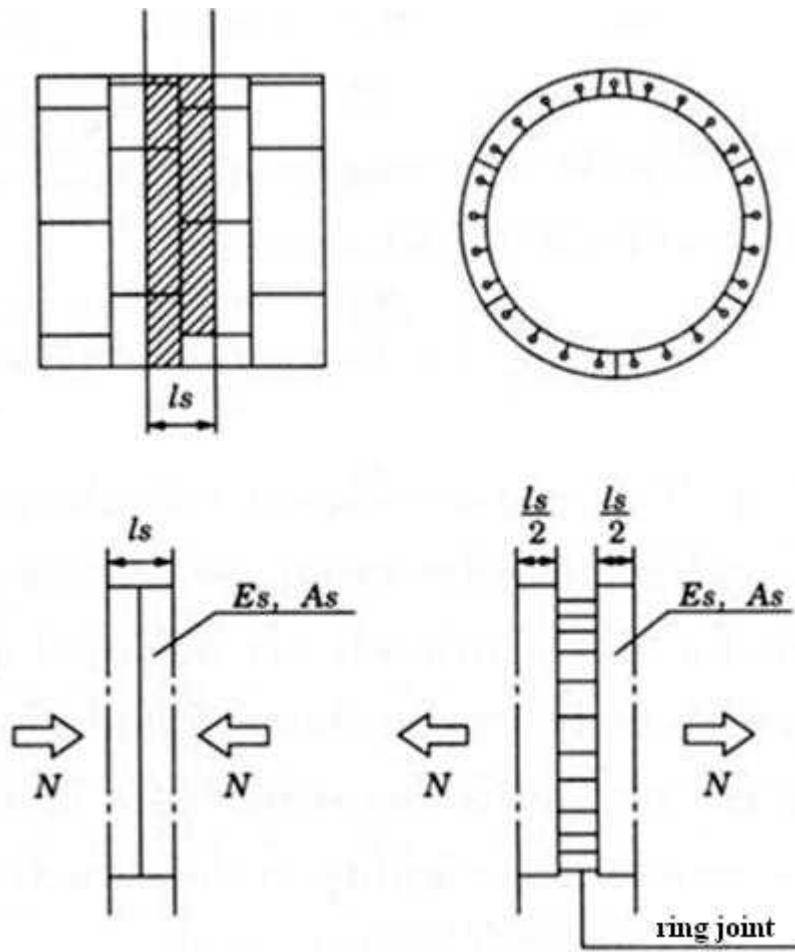

Figure 7-19 Evaluation of the equivalent axial rigidity



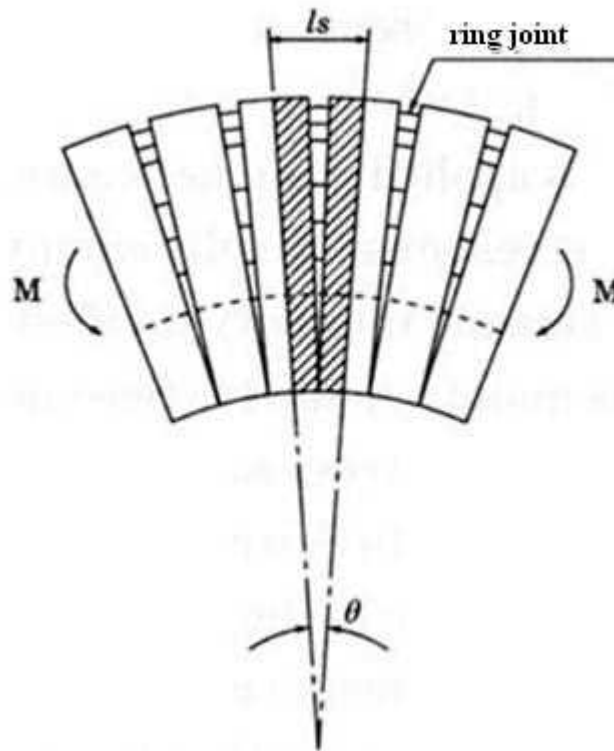

Figure 7-20: Deformation mechanism of segment joint under bending moment

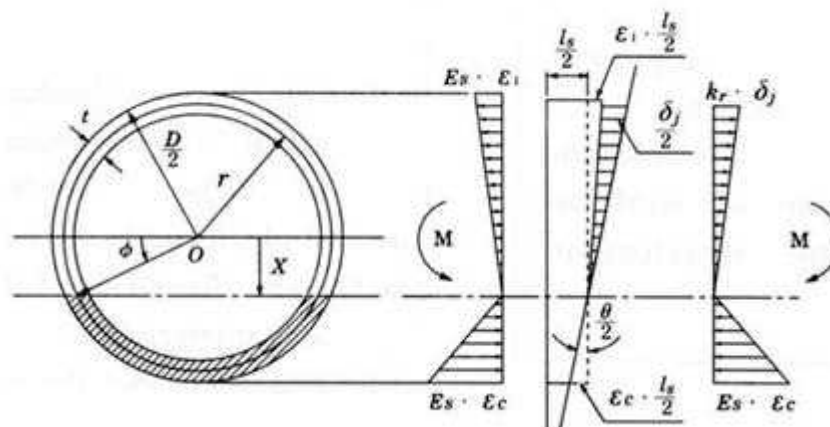

Figure 7-21: Phase one- combined stress and displacement of connector ring (when the tensile force is present in the elastic phase)

7-4-6-Calculations of shafts, conduits, common channels, and bucklers using the dynamic analysis method

1-Dynamic analyses should be carried out for seismic calculations of shafts, conduits, common channels, buckler and, if needed for the whole structure and its special sections.

- Linear analysis is basically carried out for risk level 1.
- Non-linear analysis is carried out for risk level 2.

2-In seismic calculations in order to model the structure as an integrated system, the primary and

secondary structures and adjacent grounds acts as an integrated system. Shafts, conduits and common channels should be individually considered as a whole minor system.

Description:

- 1-The dynamic analysis of seismic calculations of conduits and shafts is performed in two ways: dynamic analysis of the whole structure and dynamic analysis of part of the system. In the first method, to study movements during earthquake the primary structure, its accessorial structures and its adjacent ground should be treated as whole structure and the results should be used to design the entire structure. In the second method, seismic movement of individual sections of the structure (including the primary, connected or accessorial sections, and varying sections in the surround grounds) are studied individually for seismic design purposes. If needed, in addition to the displacement response analysis method and the quasi-static method, the dynamic analysis method is also used. Linear analysis is mainly carried out for risk level 1 to control the safety [of the structures] against stress. Non-linear analysis for risk level 2 is performed considering the structural performance constraints. Although in seismic response calculations the response spectrum method or the time response method is used, it is recommended to use both if possible. The damping factor used in the response analyses, is defined according to the standards and regulations issued in this regard.
- 2-It is recommended to use dynamic models to study the interactions such as dominant ground period, dynamic characteristics (including particular modes and damping), primary and accessorial structures in the whole structure. Since sections connected to other structures are expected to have complex movements, dynamic models of these sections need to be controlled with great precision. When the structure and the conditions of its surrounding ground are complex, the 3D FEM method is used in the dynamic model of adjacent grounds; although if creation of a proper model is possible, 2D analysis is also performed. In many dynamic models, linear springs are employed. Since it is expected for the surrounding grounds and other structures to show nonlinear behavior during strong earthquakes (including MCE), more appropriate calculations should be done. In these calculations dynamic models should be considered from the standpoint of non-linear analysis.

7-5-On-ground pipeline

7-5-1-Overview

- 1-Earthquake effects include the inertia force resulting from the weight of the structure (together with the weight of water contained in pipes), earth pressure, hydrodynamic pressure, liquefaction and ground lateral spreading.
- 2-Stress, deformation and stability of the structures should be examined when the pipes are full of water, empty and half-filled.

7-5-2-Seismic coefficient of on-ground structures in the allowable stress design method

Take measures according to section 3-1-5 of the Iranian Guideline of Loading and Seismic Analysis of Lifelines.



7-5-3-Horizontal earthquake caused by the superstructure to the substructure

- 1-Earthquake force includes the inertia force, which is determined using the quasi-static method.
- 2-Lateral loads on expansion joints of bridges are calculated based on the static friction coefficient and weight of the structure. Assuming that the junctions between the substructure and the foundations are rigid, the friction force will be generally less than the inertia force.
- 3-Combination of the above loads should be used in structural design.
- 4-The point of effect of the load is in the foundation along the axis of the bridge, which is the gravity center of the structure on the foundation in the orthographic projection.
- 5-The inertia force independently acts on two directions, which are along the bridge axis and perpendicular to it.

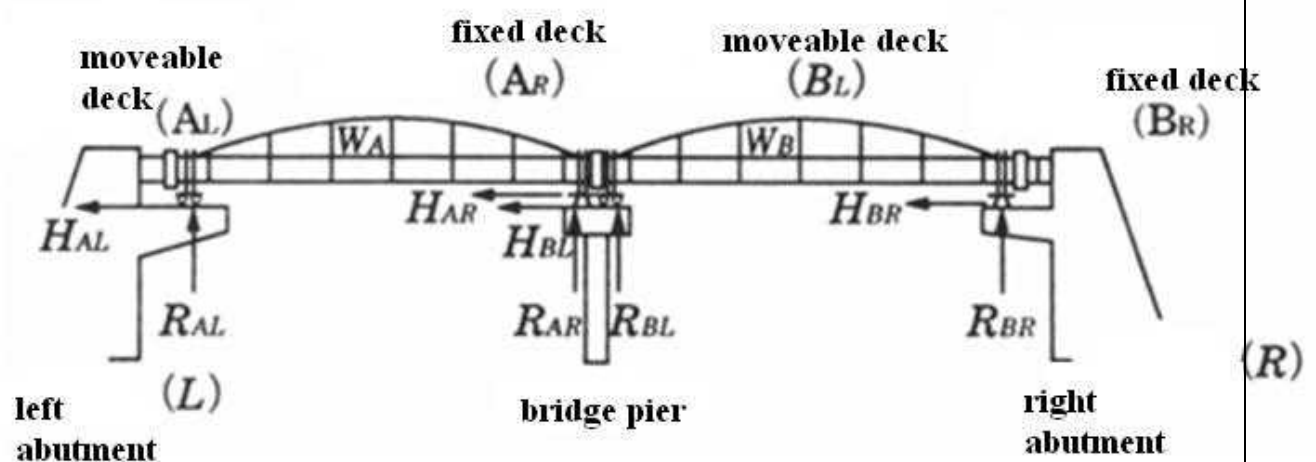

Figure 7-22: Sample inertia force acted on a bridge with two spans (A and B), two abutments (B and L), and one pier (in the middle).

7-5-4-Horizontal inertia force

- 1-The tangent (frictional) inertia force exerted on the left abutment (L) (the left part of span A is moveable):

$$H_{AL} = R_{AL} \cdot f_{AL} \quad (7-51)$$

Where:

$$H_{AL} \leq \frac{1}{2} K_{SH} \cdot W_A \quad (7-52)$$

- 2-The inertia force exerted on the middle bridge pier (H_{AB}):

$$H_{A,B} = H_{AR} + H_{BL} \quad (7-53)$$

Or

$$H_{A,B} = (K_{SH} \cdot W_A - f_{AL} \cdot R_{AL}) + f_{BL} \cdot R_{BL} \quad (7-54)$$

$$R_{AL} \cdot f_{AL} \leq \frac{1}{2} K_{SH} \cdot W_A \quad (7-55)$$

$$R_{BL} \cdot f_{BL} \leq \frac{1}{2} K_{SH} \cdot W_B \quad (7-56)$$

To ensure validity of the calculations, from the above unequal relations, the result of the sentence

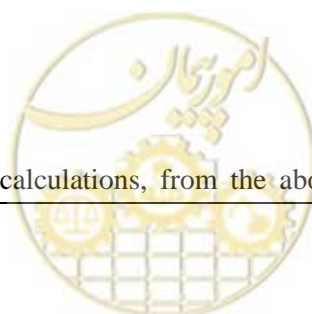

associated with the left part of span A is assumed to be zero and the result of the sentence associated with the left part of span B is assumed to be the maximum value.

3-The inertia force exerted on the right abutment (R) (the right part of span B is fixed)

$$H_{BR} = K_{SH} \cdot W_B \quad (7-57)$$

Where:

- K_{SH} : horizontal seismic coefficient
- W_B , W_A : dead load of superstructures of spans A and B (kN)
- R_{AR} , R_{AL} : responses of bridge abutments and bridge deck (L) to W_A (kN)
- R_{BR} , R_{BL} : responses of bridge abutments and bridge pier (L) to W_B (kN)
- H_{AL} : inertia or friction forced applied to bridge deck (L) by W_A (kN)
- H_{AR} : inertia force applied to bridge abutments (L) by W_A (kN)
- H_{BL} : inertia or friction force applied to bridge abutments (L) by W_B (kN)
- H_{BR} : inertia force applied to bridge deck (R) by W_B (kN)
- f_{AL} : static friction coefficient of the expansion bearing A_L
- f_{BL} : static friction coefficient of the expansion bearing B_L

The inertia force applied perpendicular to bridge axis is obtained by multiplying dead load response of each structure by the design horizontal seismic coefficient.

7-5-5-Earth pressure

Earth pressure during earthquake is calculated according to section 3-11.

7-5-6-Hydrodynamic pressure during earthquake

7-5-6-1 hydrodynamic pressure in the pipelines and channels on bridge abutments

Two methods are available for evaluation of the hydrodynamic pressure induced by water inside pipelines and channels during earthquake. In the first method, water pressure is considered as the inertia force resulted from water weight perpendicular to bridge axis. In the second method, pressure along the axial direction is neglected.

7-5-6-2-Hydrodynamic pressure in the pipelines placed on abutments

As it is shown in Figure 7-23, the deck and the pipe bodies of water pipe bridges can be considered as a whole structure. Hydrodynamic pressure is applied uniformly to the deck similar to the static pressure of water inside the pipes. Since the hydrodynamic pressure during earthquake is smaller than the water hammer, design should be carried out based on the pressure induced by water hammer. Hydrodynamic pressure should be separately studied, if its impact is significant. Cases in which hydrodynamic pressure during earthquake should be taken into account are shown below.



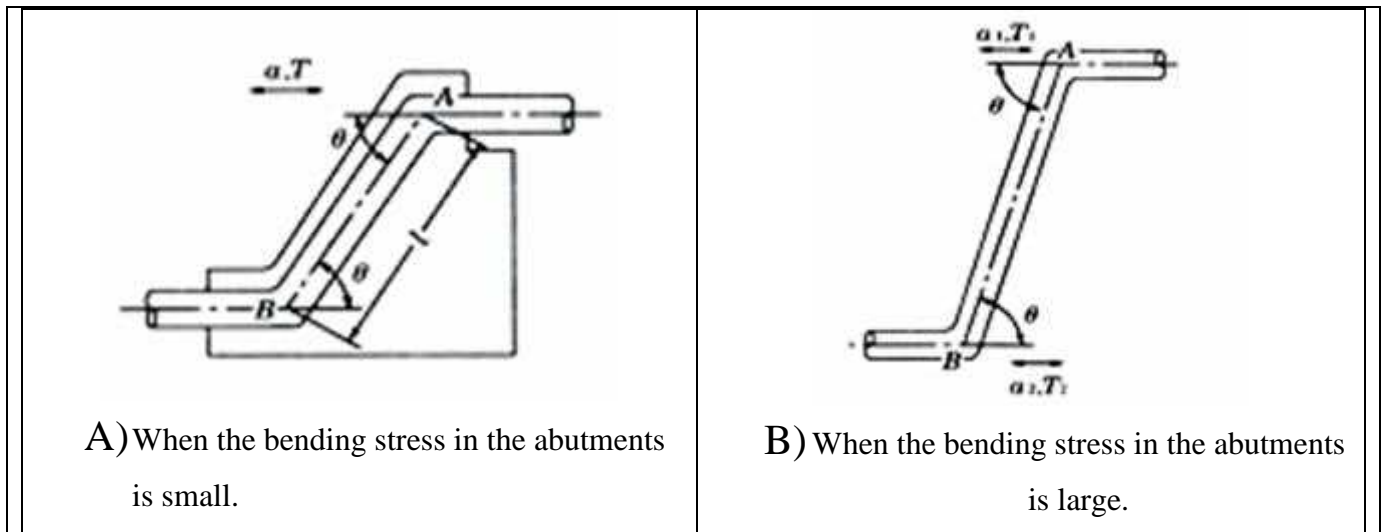

Figure 7-23: the connection between a water transmission pipe bridge and its pier.

In detailed analysis of hydrodynamic pressure the following tips shall be taken into consideration:

1-When the abutments are short, expansions and vibrations between upper and lower bending parts are equal.

When the abutments are relatively short and they are also constructed of reinforced concrete, the upper and lower parts vibrate almost equally.

Hydrodynamic pressures at the two ends of the bridge act in two opposite directions and neutralize each other's impacts.

As it is depicted in Figure 7-23 (A), the maximum hydrodynamic pressure during earthquake at point A is produced along the pipe axis and is calculated using relation 7-58. This pressure is trivial and thus is neglected in design phase.

$$\sigma'_{A_{max}} \cdot \sigma'_{B_{max}} = K_{SH} \cdot W \cdot l \left(\sin \frac{\theta}{2} \right)^2 \quad (7-58)$$

Where:

$\sigma'_{A_{max}}$, $\sigma'_{B_{max}}$: the maximum hydrodynamic pressure during earthquake at points A and B (kPa)

K_{SH} : horizontal seismic coefficient

W : water density (kN/m³)

l : distance between bending parts (m)

θ : bending angle (deg)

2-Expansions and vibrations between upper and lower bending parts of elevated abutments differ with each other.

When the abutment is elevated and is constructed of aggregates such as steel, its upper and lower parts vibrate differently. In such a case, the produced hydrodynamic pressures at the two ends do not neutralize each other's impacts, but also lead to displacements. When the maximum vibrations at two ends are combined with each other, hydrodynamic pressures during earthquake increase considerably.

$$\sigma'_{max} = \frac{(K_{SH1} T_1 + K_{SH2} T_2) \sqrt{g \cdot k \cdot W}}{2\pi \sqrt{1 + 2 \frac{k \cdot r}{E \cdot e}}} \left(\sin \frac{\theta}{2} \right)^2 \quad (7-59)$$

Where:

σ'_{\max}	: the maximum hydrodynamic pressure in the bending part (kPa)
K_{SH1}, K_{SH2}	: horizontal seismic coefficients of upper and lower flexures
T_1, T_2	: vibration periods for upper and lower parts (s)
k	: elastic modulus of water mass (2×10^6 kN/m ²)
W	: water density (kN/m ³)
r	: pipe radius (m)
E	: elastic modulus of pipe body aggregates (kN/m ²)
e	: pipe wall thickness (m)
θ	: bending angle (deg)

7-5-6-3-Hydrodynamic pressure in piers in contact with water and abutments

To obtain hydrodynamic pressure see section 3-12.

7-5-7-Bearing support structures

7-5-7-1-Overview

- 1-The bearing support section should be capable of transferring the inertia forced exerted by the equivalent horizontal seismic coefficients that are applied to the superstructure.
- 2-The bearing support should be able to bear the inertia force produced by the application of equivalent seismic coefficient only through relying on its piers.
- 3-The bearing structure should be constructed of steel.

7-5-7-2-Bearing supports design seismic force

- 1-The horizontal forced obtained from the application of the equivalent horizontal seismic coefficient is considered as the design seismic coefficient.
- 2-Seismic force is calculated for the upward and downward directions.

$$R_D = R_{Df} + \sqrt{R_{HEQ}^2 + R_{VEQ}^2} \quad (7-60)$$

$$R_U = R_{Df} - \sqrt{R_{HEQ}^2 + R_{VEQ}^2}$$

Where:

- | | |
|-----------|--|
| R_D | : downward seismic force (kN) in bearing supports |
| R_U | : upward seismic force (kN) in bearing supports.
(R_U should not exceed $-0.3R_D$ for risk level 2; hence, R_U should be equal to $-0.3R_D$. For risk level 1, R_U should be $-0.1R_D$.) |
| R_{Df} | : reaction force (kN) due to the dead load of the bearing support superstructure.
The downward reaction force should be positive. |
| R_{HEQ} | : upward and downward reaction forces (kN) due to the later seismic force present in the bearing support, when the lateral force is vertically applied to the bridge axis. |
| R_{VEQ} | : upward and downward reaction forces (kN) due to the vertical seismic force, which is expressed as a multiple of dead load: |

$$R_{VEQ} = 0.5K_{SH} \times R_{Df} \quad (7-61)$$

The upward and downward reaction forces (R_{HEQ}) in the bearing support can be calculated through relation 7-62:

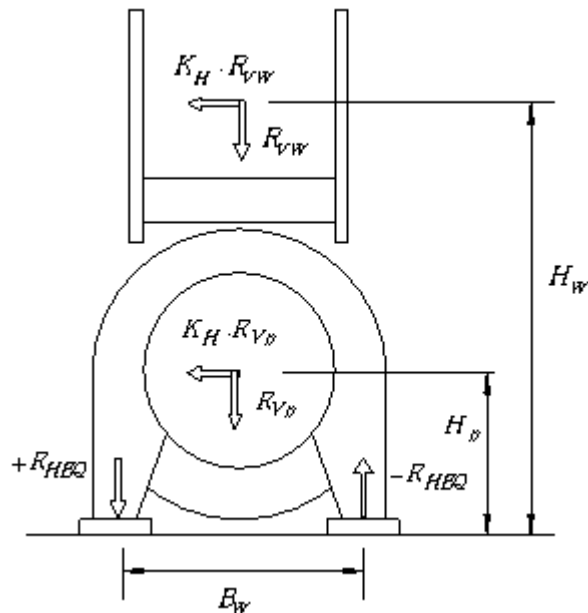

Figure 7-24 Upward and downward forces due to lateral forces

$$R_{HEQ} = \frac{K_{SH} \cdot R_{VP} \cdot H_p + K_{SH} \cdot R_{VW} \cdot H_W}{B_W}$$

Where:

K_{SH} : horizontal seismic coefficient

R_{VP} : weight of the pipe and its fluid (kN)

R_{VW} : adit weight (kN)

H_p : distance from pipe center (m)

H_W : distance from adit gravity center (m)

B_W : bearing support width (m)

7-5-7-3-Safety control of the bearing support

- 1-The strength (resistance) of the bearing support frame and also the strength of the equipments and members connected to the bearing should not be less than the design lateral seismic force. The strength of these members can be obtained from the determined allowable stress assuming a safety factor of equal to 1.5.
- 2-The strength of the bearing support should not cease the increase in the length of the expansion joint. The expansion joint should have the certain flexibility adequate for absorbing vertical displacements of the bearing support.

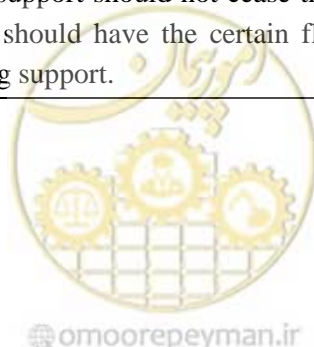

7-5-7-4-Seat length

The distance between the anchor bolts and edges of the bearing should not be less than the value of S_1 , which is calculated as below:

$$S_1 = 0.20 + 0.005L \quad (7-63)$$

Where L denotes the span length (m)

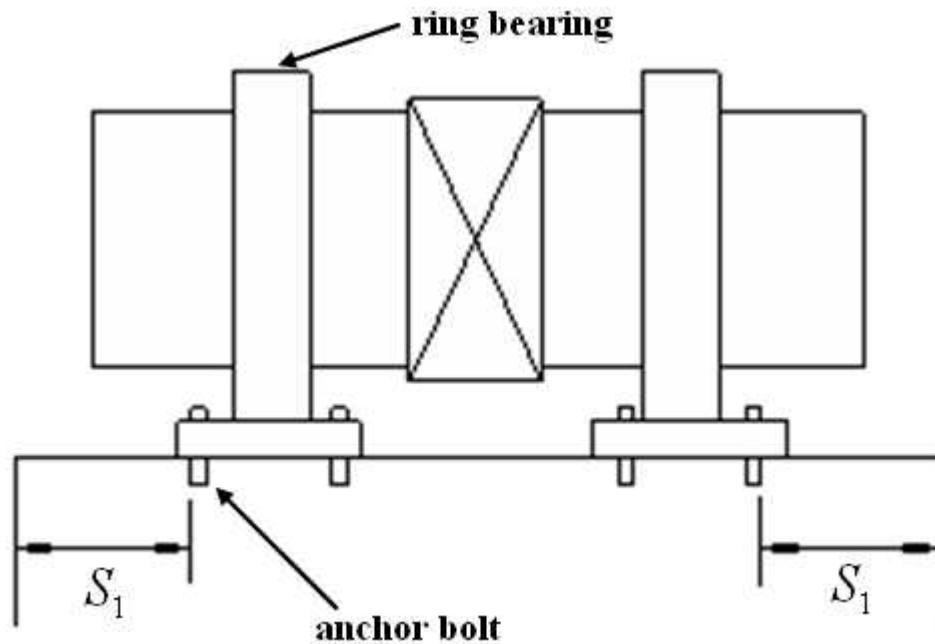

Figure 7-25: the minimum distance between anchor bolts used in the bearing

7-5-7-5-Unseating prevention systems

7-5-7-5-1-General

- (1) An unseating prevention system shall be installed that can prevent the superstructure from collapsing in the event of unexpected failure of the structural systems, owing to unseating of the structural materials or the ground.
- (2) The unseating prevention system consists of the seat length of girder at the support, unseating prevention structure, excessive displacement limiting structure, and structures for preventing the superstructure from settling. The components of the unseating prevention system shall be appropriately selected in accordance with the style of bridge, type of bearings, conditions of the ground, etc.
- (3) In a longitudinal direction to the bridge axis, the seat length of a girder at the support shall be provided at the terminal supports and at the overlapping section.
- (4) Transverse to the bridge axis, excessive displacement limiting structure shall be installed transverse to the bridge axis at the terminal supports and at the overlapping positions of the bridges and at the middle support of the continuous girders of the bridges.

7-5-7-5-2- Structure

An unseating prevention system generally includes the following components:

- 1-The structure connecting the superstructure to the substructure

- 2-Buffer structure
3-The structure connecting both sides of superstructure

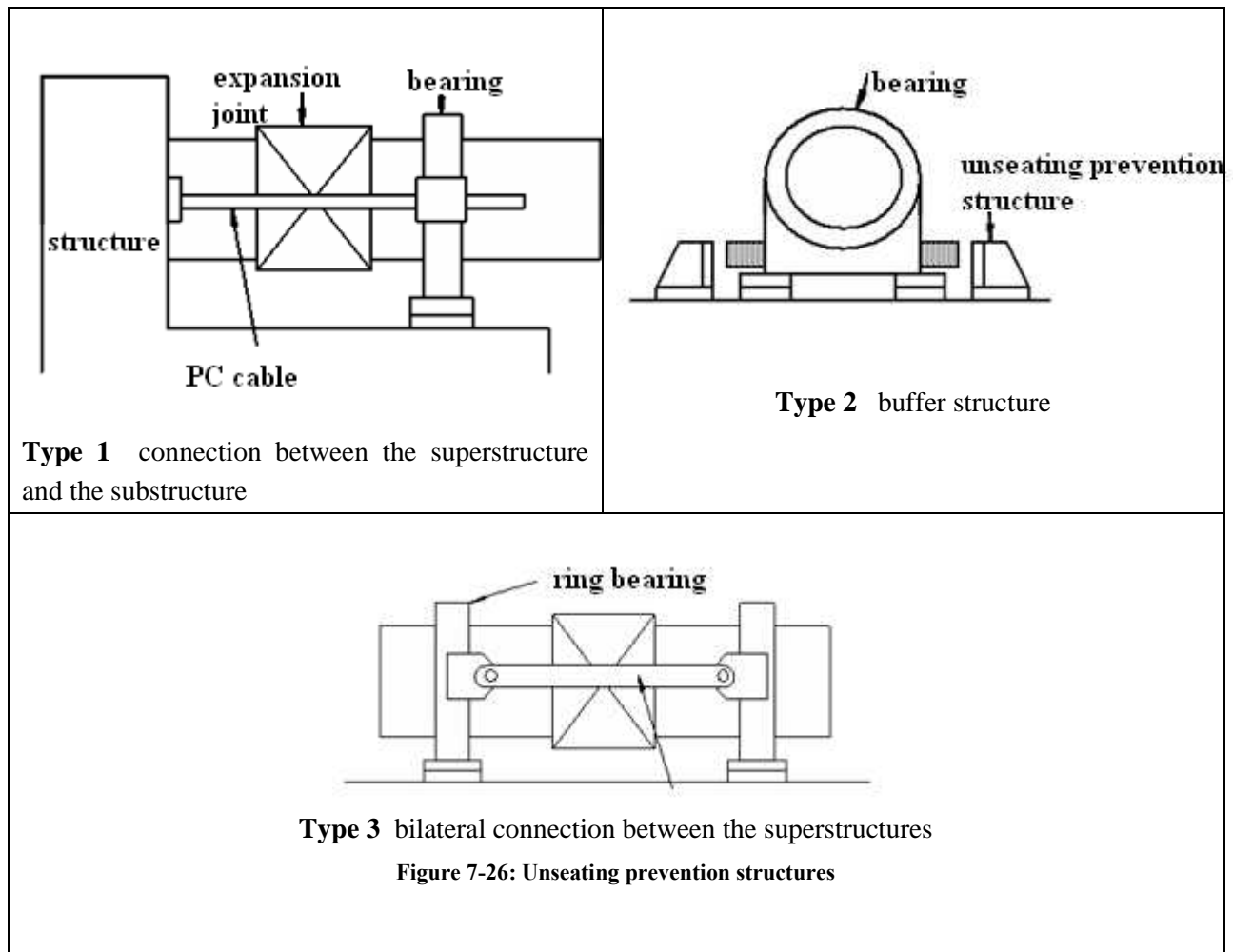

7-5-7-5-3-Design seismic force

The yield strength of unseating prevention structures should not be less than the design seismic force obtained from relation 7-64. The displacements of the unseating prevention structures should be approximately equal to the value of S_F as below:

$$H_F = 1.5R_d \quad (7-64)$$

$$S_F = c_F S_E$$

Where:

H_F : design seismic force of the unseating prevention structure (kN)

R_d : dead load response (kN)

S_F : the maximum design displacement in the unseating prevention structure (cm)

S_E : length of girder seat in the bearing support (cm)

c_F : displacement coefficient of the unseating prevention structure, which is equal to 0.75

7-5-7-5-4-Structures constraining excessive displacements

The maximum displacement of an unseating prevention structure should not exceed the allowable displacement of the expansion joint.

Description:

The maximum displacement of an unseating prevention structure can be estimated as follows:

1-For conditions with no earthquake occurrences: $\delta_x = \delta_T + \Delta_x$

2-For risk level 1: $\delta_{x1} = \delta_T + U_R + \Delta_x$

3-For risk level 2:

$$\delta_{x2} = \frac{\delta_T + U_R + U_G}{n_1} + \Delta_x$$

Where

δ_x : expansion joint displacement (mm) in non-earthquake conditions.

δ_T : displacement due to temperature growth (mm)

$$\delta_T = \alpha_t \cdot \Delta T \cdot L \quad (7-65)$$

Where:

α_t : thermal expansion coefficient (1/C°)

ΔT : temperature growth

L : length of adjacent supporting structures spans (mm)

Δ_x : allowable length of unknown excess displacements (mm)

δ_{x1} : expansion joint displacement (mm) during earthquake with risk level 1.

U_R : relative displacement (mm) of response displacements of adjacent bearing structures

$$U_R = \sqrt{U_{R1}^2 + U_{R2}^2} \quad (7-66)$$

Where:

U_{R1} : response displacement of bearing support structure 1 (mm)

U_{R2} : response displacement of bearing support structure 2 (mm)

δ_{x2} : expansion joint displacement (mm) during risk level 2

U_G : relative displacement (mm) due to the deformation of the ground between adjacent bearing structures

$$U_G = \varepsilon_G \cdot L \quad (7-67)$$

Where:

ε_G : open field strain on ground surface

n_1 : number of expansion joints

7-5-8-Allowable quantities of buried pipelines

- 1-The maximum allowable strain or the junction displacement is defined based on design purposes.
- 2-For risk-level-1 earthquakes, the critical strain of the low-cycle fatigue failure mode of wave effect is the minimum value between 0.11% and the buckling threshold strain ($23 t/D$.)
- 3-For risk-level-2 earthquakes, the critical strain of the low-cycle fatigue failure mode of wave effect is $46t/D$.
- 4-Critical displacement of mechanical joints is defined based on the nominal values of these joints, which include mechanical joints, joggle joints, expansion joints, and spiral joints.

5-Critical displacement is determined based on the JIS test flow, when the containing air starts to leak or when field bolts or rings break.

Table 7-2: Critical quantities of pipelines

Earthquake	Seismic load	Components	Failure mode	Unit	Criterion
Risk level 1	Wave effect	Unbroken pipe	Fatigue failure or low cycle	Strain	0.11%
			buckling		$\frac{23t}{D}$
Risk level 2	Wave effect	Unbroken effect	Buckling		$\frac{46t}{D}$

7-6-Criteria

7-6-1-On-ground pipeline

Relation 7-68 should be satisfied for each failure modes of pipeline bridges.

$$Q_p \leq Q_{pa} \quad (7-68)$$

Where:

Q_p : response load for each failure mode

Q_{pa} : allowable load for each failure mode

7-6-2-Buried pipelines

7-6-2-1-Disjoint pipeline in the plastic design method regardless of soil slippage

1-Stress

Pipe body stress \leq allowable stress (yield strength) or (jack movement)

2-Joint displacement

Displacement \leq maximum expansion displacement for construction design control

7-6-2-2-Disjoint pipeline in the plastic design method regarding soil slippage

1-Stress

Pipe body stress \leq allowable stress (yield strength) or (jack movement)

2-Joint displacement

Displacement \leq maximum expansion displacement for construction design control

7-6-2-3-Unbroken pipeline in the allowable stress design method

Pipe body stress \leq allowable stress (yield strength)

7-6-2-4-Unbroken pipeline in the plastic design method

Pipe strain \leq allowable strain

